

**IAEA COMPREHENSIVE
REPORT ON THE
SAFETY REVIEW
OF THE ALPS-TREATED
WATER AT THE
FUKUSHIMA DAIICHI
NUCLEAR POWER STATION**



IAEA

International Atomic Energy Agency

© IAEA, 2023

This is a report by the IAEA of the IAEA Review of Safety Related Aspects of Handling ALPS-Treated Water at TEPCO's Fukushima Daiichi Nuclear Power Station. The views expressed herein do not necessarily reflect those of IAEA Member States. Although great care has been taken to maintain the accuracy of information contained in this report, neither the IAEA nor its Member States assume any responsibility for consequences which may arise from its use. The use of particular designations of countries or territories does not imply any judgement by the IAEA, as to the legal status of such countries or territories, of their authorities and institutions or of the delimitation of their boundaries. The mention of names of specific companies or products (whether or not indicated as registered) does not imply any intention to infringe proprietary rights, nor should it be construed as an endorsement or recommendation on the part of the IAEA. The IAEA assumes no responsibility for the accuracy or continuing existence of URLs for external or third party internet web sites referred to in this report and does not guarantee that any content on such web sites is, or will remain, accurate or appropriate.

**IAEA COMPREHENSIVE
REPORT ON THE
SAFETY REVIEW
OF THE ALPS-TREATED
WATER AT THE
FUKUSHIMA DAIICHI
NUCLEAR POWER STATION**

Outline of the IAEA Comprehensive Report

Director General's Foreword	III
Executive Summary	IV
PART 1 INTRODUCTION	1
1.1. Background	1
1.2. The Comprehensive Report	9
1.3. The IAEA international safety standards	10
PART 2 ASSESSMENT OF CONSISTENCY WITH THE FUNDAMENTAL SAFETY PRINCIPLES	13
2.1. Responsibility for Safety	14
2.2. Role of the Government	15
2.3. Leadership and Management for Safety	17
2.4. Justification	18
2.5. Optimization of Protection	20
2.6. Limitation of Risks to Individuals	23
2.7. Protection of Present and Future Generations and their Environment	25
2.8. Prevention of Accidents	28
2.9. Emergency Preparedness and Response	29
2.10. Protective Actions to Reduce Existing Radiation Risks	31
PART 3 ASSESSMENT OF CONSISTENCY WITH SAFETY REQUIREMENTS	33
3.1. Regulatory Control and Authorization	33
3.2. Safety Related Aspects of Systems and Processes for Controlling Discharges	43
3.3. Characterization of the Source	54
3.4. Radiological Environmental Impact Assessment	59
3.5. Source and Environmental Monitoring	84
3.6. Involvement of Interested Parties	94
3.7. Occupational Radiation Protection	98
PART 4 MONITORING, ANALYSIS, AND CORROBORATION	103
4.1. Overview of Corroboration Activities	103
PART 5 FUTURE ACTIVITIES	111
5.1. Review Missions	112
5.2. IAEA's Independent Sampling, Data Corroboration, and Analysis	114
5.3. Real Time Monitoring	115
5.4. IAEA Continuous Presence at the FDNPS	116
REFERENCES	117
LIST OF CONTRIBUTORS	119
ANNEX 1: Summary of IAEA Review Missions and Published Technical Reports	121
ANNEX 2: Summary of relevant international safety standards used in the IAEA safety review	122
ANNEX 3: List of updates and amendments to TEPCO's Implementation Plan and NRA Regulatory Review Milestones	123
ANNEX 4: Japan legal and regulatory provisions applied to the FDNPS	125
ANNEX 5: Tritium in the Environment	129

Director General's Foreword

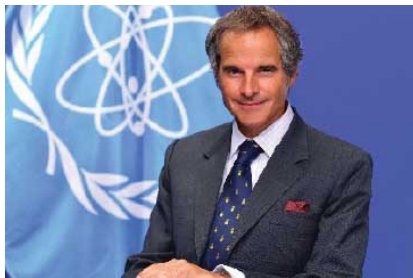

The accident at Fukushima Daichi Nuclear Power Station in March 2011 and the subsequent operations at the plant have resulted in the accumulation of large amounts of water stored on the site. In April 2021, the Government of Japan published its policy on how it would manage this water. It decided to discharge it gradually into the sea after specific treatment.

Shortly after the decision was made, the Government of Japan requested that the IAEA undertake an independent safety review of Japan's implementation of its policy against the international safety standards.

I agreed with Japan that the IAEA would review the implementation of the Government's plans comprehensively before, during, and after any discharge of the ALPS-treated water.

That year, I established an IAEA Task Force. It is made up of top specialists from within the IAEA's Secretariat advised by internationally recognized outside experts from across the globe, including within the region.

By the nature of its statutory mandate and global reach, the IAEA is able to use the internationally agreed nuclear safety standards as an objective blueprint for assessing the safety of the planned discharges. These international standards are constantly updated, taking into account advances in science and technology and learnings from research and experience. They serve as the indispensable global reference for protecting people and the environment, thereby contributing greatly to a harmonized and high level of nuclear safety worldwide.

This comprehensive report makes the science of the treated water release clear for the international community and I believe answers the technical questions related to safety that have been raised.

Based on its comprehensive assessment, the IAEA has concluded that the approach and activities to the discharge of ALPS treated water taken by Japan are consistent with relevant international safety standards. Furthermore, the IAEA notes the controlled, gradual discharges of the treated water to the sea, as currently planned and assessed by TEPCO, would have a negligible radiological impact on people and the environment.

These findings and this comprehensive report represent a significant milestone in the IAEA's review. Even so, our task is only just beginning.

The IAEA will continue its impartial, independent and objective safety review during the discharge phase, including by having a continuous on-site presence and by providing live online monitoring on our website. This will ensure the relevant international safety standards continue to be applied throughout the decades-long process laid out by the Government of Japan and TEPCO. By doing so, the IAEA will continue to provide transparency to the international community making it possible for all stakeholders to rely on verified fact and science to inform their understanding of this matter throughout the process.

Finally, I would like to emphasise that the release of the treated water stored at Fukushima Daiichi Power Station is a national decision by the Government of Japan and that this report is neither a recommendation nor an endorsement of that policy. However, I hope that all who have an interest in this decision will welcome the IAEA's independent and transparent review, and I give an assurance, as I said right at the start of this process, that the IAEA will be there before, during and after the discharge of ALPS treated water.

Rafael Mariano Grossi
Director General, IAEA

Executive Summary

In April 2021, the Government of Japan released its *Basic Policy on Handling of ALPS Treated Water at the Tokyo Electric Power Company Holdings' (TEPCO) Fukushima Daiichi Nuclear Power Station* (Basic Policy). This policy resulted from a programme of review by the relevant Japanese government ministries, and TEPCO, about how to manage the accumulating ALPS treated water stored on site at the Fukushima Daiichi Nuclear Power Station (FDNPS). The Basic Policy describes, among other topics, the method selected by the Government of Japan for the handling of the Advanced Liquid Processing System (ALPS) treated water which was to discharge the treated water into the sea.

Following the announcement of this policy, the Government of Japan requested that the IAEA conduct a detail review of the safety related aspects of handling ALPS treated water stored at FDNPS, applying the relevant international safety standards. The IAEA Director General accepted this request and noted the IAEA's commitment to being involved before, during, and after the ALPS treated water discharges. The IAEA is conducting this review in compliance with its relevant IAEA statutory functions, in particular, that established in Article 3.A.6 of the IAEA Statute which declares that the Agency is authorized:

“To establish or adopt, in consultation and, where appropriate, in collaboration with the competent organs of the United Nations and with the specialized agencies concerned, standards of safety for protection of health and minimization of danger to life and property (including such standards for labour conditions), ... and to provide for the application of these standards, ... at the request of a State, to any of that State's activities in the field of atomic energy.”

In July 2021, the IAEA and the Government of Japan signed the Terms of Reference for IAEA Assistance to Japan on Review of Safety Aspects of ALPS Treated Water at TEPCO's FDNPS. The IAEA activities in this regard consist of a technical review to assess whether the actions of TEPCO and the Government of Japan to discharge the ALPS treated water over the coming decades are consistent with international safety standards. The IAEA is also undertaking all necessary activities for the corroboration of the source and environmental monitoring programmes of TEPCO and the Government of Japan before, during and after the discharges. The IAEA's review is organized into the following three major components to ensure all key safety elements are adequately addressed: 1) Assessment of Protection and Safety, 2) Regulatory Activities and Processes, and 3) Independent Sampling, Data Corroboration, and Analysis.

To implement the IAEA's review in a transparent and inclusive manner, the IAEA Director General established a Task Force. The Task Force operates under the authority of the IAEA and is chaired by a senior IAEA official. The Task Force includes experts from the IAEA Secretariat alongside internationally recognized independent experts with extensive experience from a wide range of technical specialties from Argentina, Australia, Canada, China, France, the Marshall Islands, the Republic of Korea, the Russian Federation, the United Kingdom, the United States and Viet Nam. These independent experts provide advice and serve on the Task Force in their individual professional capacity to help ensure the IAEA's review is comprehensive, benefits from the best international expertise and includes a diverse range of technical viewpoints.

Since September 2021 when the IAEA Task Force held its first meeting, there have been five review missions, six technical reports, and numerous Task Force meetings. A summary of these activities and key milestones are included in Annex 1. Throughout this process the Task Force received information from the Government of Japan and TEPCO which helped the experts to better understand the technical and regulatory aspects of the planned discharges of ALPS treated water. The technical reports of the missions include summaries of the IAEA's review and show the progress made by TEPCO and the Government of Japan. Over the past two years, the Task Force and the Government of Japan have identified and built on

the observations from these previous missions and the IAEA is now in a position to draw comprehensive conclusions about the safety of the discharge. Additionally, this review is occurring concurrently with Japan's Nuclear Regulation Authority's (NRA) domestic regulatory review and approval. Therefore, the insights from the IAEA's review were considered in the domestic process in a timely and beneficial manner.

This comprehensive report includes explanations and insights over a broad range of topics that are important to understanding the overall safety-related aspects of this process; this represents the "before" stage of the IAEA's review as noted by the IAEA Director General. The purpose of this comprehensive report is to present the IAEA's final conclusions and findings of the technical review to assess whether the planned operation to discharge the ALPS treated water into the Pacific Ocean over the coming decades is consistent with relevant international safety standards. The reviews of individual topics included in this comprehensive report are based on hundreds of pages of technical and regulatory documentation, condensed and summarized to help make the conclusions from the IAEA's review more accessible and understandable for the general public. A summary of relevant international safety standards is included in Annex 2.

In order to fully assess whether the ALPS treated water discharge is conducted in a manner that is consistent with relevant international safety standards, the Task Force considered the Fundamental Principles for Safety, the Safety Requirements, and the supporting Safety Guides, published by the IAEA. These standards are standards of safety for the protection of health and minimization of danger to life and property. In compliance with the IAEA's statutory functions, these international safety standards are developed and co-sponsored in consultation with and, where appropriate, in collaboration with the competent organs of the United Nations and with specialized agencies. They serve as a global reference for protecting people and the environment and contribute to a harmonized high level of safety worldwide.

This report includes an assessment of the application of the fundamental safety principles, the relevant safety requirements, and supporting safety guides. It is important to note that in the application of the international safety standards, their principles and technical considerations, must be adapted to national circumstances.

Based on its comprehensive assessment, the IAEA has concluded that the approach to the discharge of ALPS treated water into the sea, and the associated activities by TEPCO, NRA, and the Government of Japan, are consistent with relevant international safety standards.

The IAEA recognizes that the discharge of the ALPS treated water has raised societal, political and environmental concerns, associated with the radiological aspects. However, the IAEA has concluded, based on its comprehensive assessment, that the discharge of the ALPS treated water, as currently planned by TEPCO, will have a negligible radiological impact on people and the environment.

Notwithstanding the above conclusions, the IAEA notes that once any discharges begin, many of the technical topics reviewed and assessed by the Task Force will need to be revisited by the IAEA at various times to assess the consistency of activities during the operation of the ALPS treated water discharges with relevant international safety standards.

On May 2023, the IAEA published a report detailing the results of the first interlaboratory comparison conducted for the determination of radionuclides in samples of ALPS treated water. These findings provide confidence in TEPCO's capability for undertaking accurate and precise measurements related to the discharge of ALPS treated water. Furthermore, based on the observations of the IAEA, TEPCO has demonstrated that it has a sustainable and robust analytical system in place to support the ongoing technical needs at FDNPS during the discharge of ALPS treated water.

The IAEA is committed to engaging with Japan on the discharge of ALPS treated water not only before, but also during, and after the treated water discharges occur. The findings above relate to activities the Task

Force performed before the water discharges start. However, the work of the IAEA and the Task Force will continue for many years. The IAEA will maintain an onsite presence at FDNPS throughout its review and will publish available data for use by the global community, including the provision of real-time and near real-time monitoring data from FDNPS. Additional review and monitoring activities are envisaged that will continue and which will provide additional transparency and reassurance to the international community by continuously providing for the application of the relevant international safety standards.

PART 1

INTRODUCTION

1.1. Background

The Accident at the Fukushima Daiichi Nuclear Power Station

The Great East Japan Earthquake occurred on 11 March 2011 with a magnitude of 9.0 and subsequently causing a tsunami which struck a wide area of coastal Japan, including the north-eastern coast, where several waves reached heights of more than ten metres. The earthquake and tsunami caused great loss of life and widespread devastation in Japan. Around 20,000 people were killed, and over 6,000 were injured. Considerable damage was caused to buildings and infrastructure, particularly along Japan's north-eastern coast.

At the Fukushima Daiichi Nuclear Power Station (FDNPS), operated by the Tokyo Electric Power Company (TEPCO), the earthquake caused damage to the electric power supply lines to the site, and the tsunami caused substantial destruction of the operational and safety infrastructure on the site. The combined effect led to the loss of on-site and off-site electrical power. This resulted in the loss of the cooling function at the three operating reactor units as well as at the spent fuel pools. Four other nuclear power plants along the coast were also affected to differing degrees by the earthquake and tsunami. However, all operating reactor units at these plants were safely shut down.

Despite the efforts of the operators at the FDNPS to maintain control, the reactor cores in Units 1, 2 and 3 overheated, the nuclear fuel melted, and the three containment vessels were breached. Hydrogen was released from the reactor pressure vessels, leading to explosions inside the reactor buildings in Units 1, 3 and 4 that damaged structures and equipment and injured personnel. Radionuclides were released from the plant to the atmosphere and were deposited on land and on the ocean. There were also direct releases into the sea. People within a radius of 20 km of the site and in other designated areas were evacuated, and those within a radius of 20–30 km were instructed to shelter before later being advised to voluntarily evacuate. Restrictions were placed on the distribution and consumption of food and the consumption of drinking water.

Following stabilization of the conditions of the reactors at the FDNPS, the work on decommissioning began and has been underway since. Efforts towards the recovery of the areas affected by the accident, including remediation and the revitalization of communities and infrastructure, began in 2011.

Management of Contaminated Water at FDNPS

Before the accident, groundwater flowing from the mountainside to the rear of the FDNPS was pumped at a rate of approximately 850 m³ per day from sub-drains located around the buildings of Units 1–4 to control the groundwater level and avoid localized flooding. Because of the accident, the sub-drains and pumps that prevented groundwater from entering the buildings ceased operation. Since the reactor vessels are no longer intact, and the nuclear material from the cores are no longer contained in the reactor vessels, the groundwater coming into the reactor buildings can mix with radioactive debris resulting in contaminated water. Additionally, the ground water that enters the reactor buildings is also used to cool the fuel debris in order to keep the reactors in a stable condition. Finally, due to the degraded conditions of the reactor buildings, rainwater is able to enter the building and mix with the fuel debris as well.

The contaminated water, which is highly radioactive, is collected by TEPCO and stored on site in special tanks to prevent it from reaching the environment in its current state (see Figure 1.2). However, as the contaminated water is highly radioactive, the storage of large quantities on site has led to higher doses for workers on site and difficulties for TEPCO in reaching the site boundary dose target of 1 mSv per year. These challenges led TEPCO to develop the Advanced Liquid Processing System (ALPS) which is used to remove most of the radioactive contamination from the water and thus reduce the dose to workers from this stored water. Additionally, TEPCO has been working to reduce the amount of contaminated water produced each day. Various water management techniques have been deployed, and implemented, including the installation of additional treatment systems and storage tanks, a sub-drain system, and the installation of seaside impermeable walls (see Figure 1.1). Additionally, uncontaminated groundwater from uphill of the damaged facilities is being routed around the facilities and into the ocean. In addition, a cryogenic ‘frozen’ wall around the reactor buildings and on the seaside was constructed to prevent further water ingress. All of these measures have helped to reduce the production of contaminated water from approximately 540 m³ per day to 90 m³ per day [2].

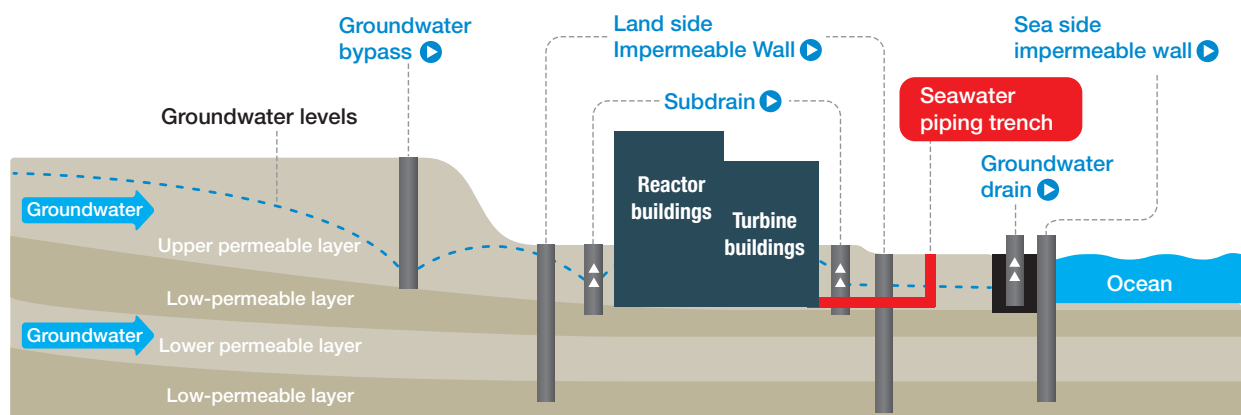

Figure 1.1. Groundwater flow through the FDNPS



Figure 1.2. Storage tanks for contaminated water at FDNPS

Description of the Advanced Liquid Processing System and Other Treatment Systems

As noted previously, contaminated water stored on site is treated to remove most of the radioactive content, except for tritium, which cannot be removed by the ALPS system, or any other industrial scale system (based on existing technology) given the volume of water and low tritium concentrations involved. Multiple steps are involved in the treatment process, as shown in Figure 1.3. Prior to being treated by the ALPS system, the contaminated water has caesium and strontium removed periodically through the KURION and SARRY systems; caesium and strontium account for most of the radioactivity from the contaminated water. Then, when the water is no longer intended to be used for cooling the fuel debris, it is sent for ALPS treatment where 62 additional radionuclides are removed (see Figure 1.4). It is important to note that the ALPS treatment process does not remove all radioactive material. Small amounts of different radionuclides remain in the water (although they are well below regulatory limits) even after treatment, and tritium is not removed by the ALPS system at all.

The ALPS system is fundamentally, a pumping and filtration system which uses a series of chemical reactions to remove 62 radionuclides from the contaminated water. The radioactive material removed from the water is captured in filters which are stored on site in special containers called High Integrity Containers (HIC). After going through the ALPS treatment process, the water is called “treated water” or “ALPS treated water” and is then stored in large tanks on site (approximately 1,000 m³ each). These tanks are all given alphanumeric codes to uniquely identify them, such as K4B. Currently there are over 1000 tanks on site at FDNPS.

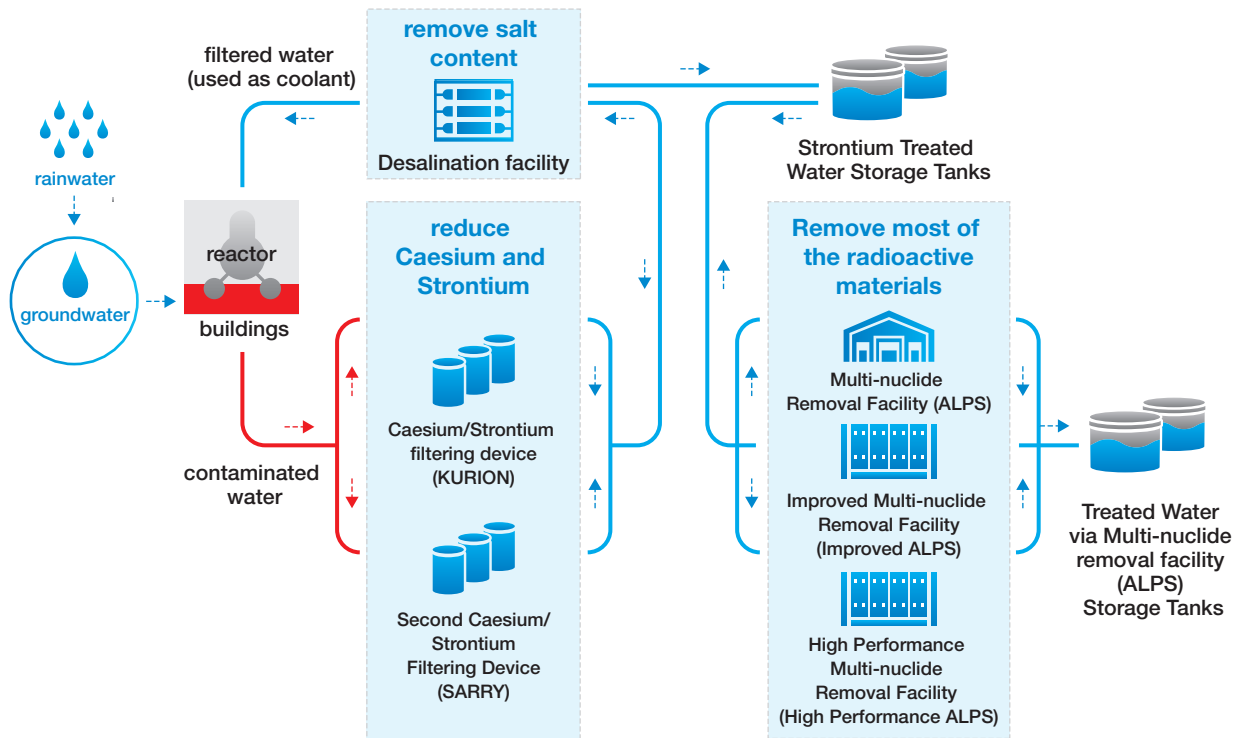

Figure 1.3. ALPS treatment process

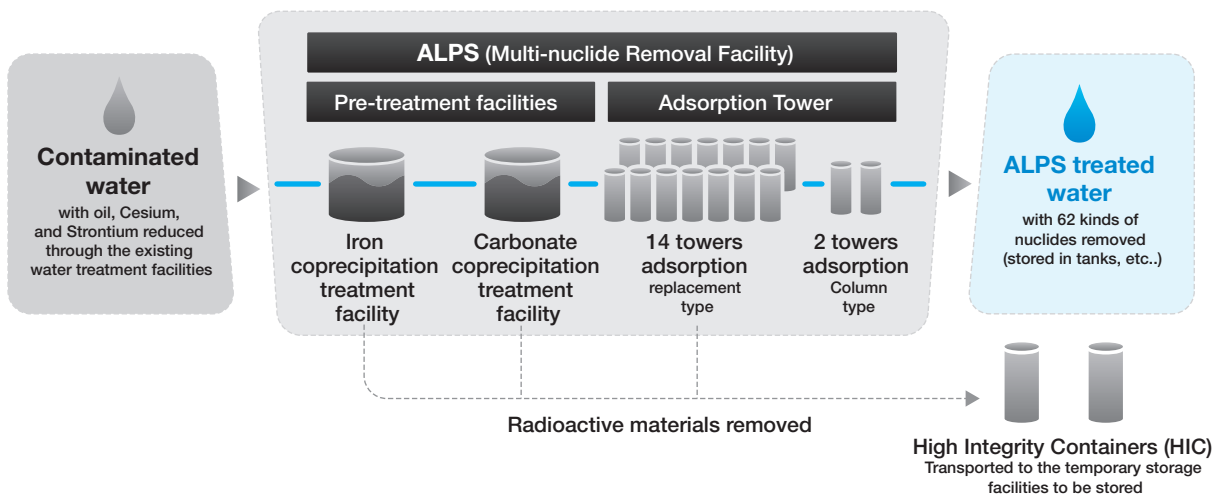

Figure 1.4. Details of ALPS treatment process to remove radionuclides

Government of Japan’s decision on the disposal of the treated water.

In December 2013, the Committee on Countermeasures for Contaminated Water Treatment drafted a document entitled “Preventative and Multi-layered Measures Utilizing Enhanced Comprehensive Risk Management for Contaminated Water Treatment at Tokyo Electric Power Company’s Fukushima Daiichi Nuclear Power Station.” The document identified that issues would remain unresolved concerning the handling of the ALPS treated water even if various countermeasures were taken, including “removing” the contamination source, “redirecting” groundwater from the contamination source and “preventing leakage” of contaminated water due to the storage of the ALPS treated water which would increase the number of tanks to be managed, resulting in the potential for more leakage events to occur.

In addition, in December 2013, an IAEA Review Mission provided an advisory comment concerning the handling of the ALPS treated water, that “all options should be examined.” Accordingly, to assess a variety of options for the handling of the ALPS treated water, the Tritiated Water Task Force, comprised of technical experts from outside the Government of Japan, was established under the Committee on Countermeasures for Contaminated Water Treatment. As a result, the Tritiated Water Task Force began a review in December 2013 and published a report in June 2016. In September 2016, the Committee on Countermeasures for Contaminated Water Treatment decided to establish an ALPS subcommittee, comprised of technical experts from outside of the Government of Japan, to discuss the handling of the ALPS treated water from all viewpoints, including social perspectives. The ALPS subcommittee’s intent was to provide an independent point of view for the Government of Japan to utilize when deciding how to dispose of the ALPS treated water, also taking into account the opinions of a wide range of the parties concerned.

The Tritiated Water Task Force and the ALPS subcommittee conducted comprehensive discussions on this matter over a period of more than six years. The ALPS subcommittee organized many explanatory meetings and public hearings to hear opinions about the ALPS treated water disposal pathway and concerns. The main topics analysed by the subcommittee were: the review of the current conditions of the ALPS treated water including the progress of contaminated water management and generation and storage, the characteristics of the ALPS treated water, the status of disposal of radioactive waste including tritium in and outside Japan, the examination on disposal paths, duration, amount, timing and monitoring of the release, reputational damage and countermeasures in the case of the disposal of the ALPS treated water.

In February 2020, an ALPS Subcommittee report was released [3]. The report concluded that, of the five disposal methods analysed in detail (out of many more theoretical options considered), vapor release and controlled discharges into the sea were the most practical options taking into account safety concerns, the existing technology available, and time constraints. The report also concluded that discharge into the sea could be “implemented more reliably, with respect to mitigating environmental and human health impacts, given that this discharge method is commonly used among nuclear plants around the world; discharge facilities have positive track records for safety; and controlled discharges into the sea can be monitored most accurately.”

In response to the ALPS Subcommittee report, in April of the same year, the report from an IAEA decommissioning mission [4] stated that “the recommendations made by the ALPS Subcommittee are based on a sufficiently comprehensive analysis and on a sound scientific and technical basis” and noted that the two options (vapor release and discharge into the sea) are “technically feasible”.

In April 2021, the Government of Japan announced the Basic Policy on Handling of ALPS Treated Water at the Tokyo Electric Company Holdings’ Fukushima Daiichi Nuclear Power Station., The Basic Policy contains the Government of Japan’s basic premise, relevant background and an outline for pursuing discharge of ALPS treated water into the sea. In the Basic Policy the Government of Japan notes: “In order to safely and steadily proceed with decommissioning and management of contaminated water and treated water at FDNPS, based on the ALPS Subcommittee report and opinions received from parties concerned, the ALPS treated water will be discharged on the condition that full compliance with the laws and regulations is observed, and measures to minimize adverse impacts on reputation are thoroughly implemented.”

The Basic Policy further notes that “...[the] discharge of ALPS treated water into the sea will be implemented at Fukushima Daiichi NPS, on the premise to make best efforts to minimize the risks by taking measures such as purification and dilution based on the ALARA principle, under strict control.” In support of this decision, the Basic Policy provides background and supporting justification such as the importance of risk reduction, protecting people and the environment and ensuring that reconstruction of Fukushima can be supported. Furthermore, the Basic Policy highlights the work of the Inter-Ministerial

Council in assessing other technologies for handling and managing ALPS treated water stored at the Fukushima Daiichi Nuclear Power Station.

The current approach outlined in the Basic Policy is to conduct a series of controlled discharges of ALPS treated water into the sea ('batch discharges') over a period of approximately 30 years.

Facilities for discharging ALPS treated water

A diagram of the facilities for discharging ALPS treated water into the sea (Figure 1.5). The facilities are composed of four main components. A brief summary is included below, and a more detailed description is included in Part 3 (Section 3.2) of this report.

- The measurement and confirmation facility: The water to be discharged is received by the measurement and confirmation facility and is homogenized by installed agitators. The water is then sampled by TEPCO and sent to onsite analytical laboratories. The water samples are analysed for a wide range of radionuclides and TEPCO verifies whether the ALPS treated water contained in the tanks are ready for discharge (i.e., the small amount of radioactive material left in the water, except for tritium, meets domestic regulatory limits).
- The transfer facility: Once verified by analysis, the water is transferred by pumps and piping from the measurement and confirmation facility to the dilution facility. The pumps, piping, valves, and other engineered controls associated with this step are considered the transfer facility.
- The dilution facility: Further downstream, ALPS treated water is mixed with seawater in a large section of piping called a header. The seawater header receives seawater from three piping lines which are each connected to a seawater pump. The Unit 5 intake channel is used as the source of the seawater.
- The discharge facility: which consists of the discharge vertical shaft, discharge tunnel and discharge outlet. The discharge of ALPS treated water occurs through a tunnel running under the seabed about one kilometre off the coast.

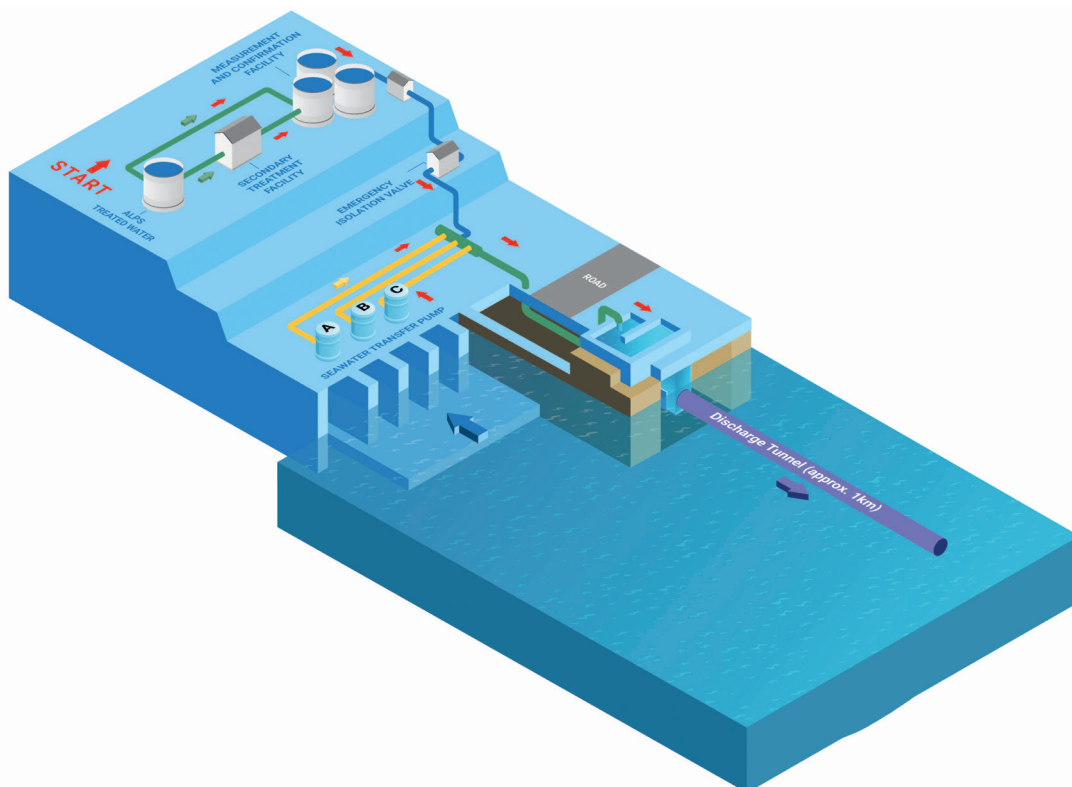

Figure 1.5. A diagram of the facilities for discharging ALPS treated water into the sea

Government of Japan Request and IAEA's Response

In April 2021, Japan announced its Basic Policy and soon after, the Japanese authorities requested assistance from the IAEA to monitor and review those plans and activities relating to the discharge of the treated water to ensure they will be implemented in a safe and transparent way, and they will be consistent with the IAEA's international safety standards. The IAEA, in line with its statutory responsibility, accepted the request made by Japan.

In July 2021, the IAEA and the Government of Japan signed the Terms of Reference for IAEA Assistance to Japan on Review of Safety Aspects of ALPS Treated Water at Tokyo Electric Power Company Holdings, Inc. (TEPCO) Fukushima Daiichi Nuclear Power Station (FDNPS). These terms of reference set out the broad framework that the IAEA will use to implement its review. Such a request to the IAEA, and its acceptance by the IAEA, is in accordance with the IAEA function described in Article III.A.6 of the IAEA Statute.

In September 2021, the IAEA sent a team to Tokyo, for meetings and discussions to finalize the agreement on the scope, key milestones and approximate timeline for the Agency's review. The team also travelled to the FDNPS to discuss technical details with experts at the site and to identify key activities and locations of interest for the Agency's review.

To implement the IAEA's review in a fully transparent and inclusive manner, the IAEA Director General established a Task Force. The Task Force operates under the authority of the IAEA and is chaired by a senior IAEA official. The Task Force includes experts from the IAEA Secretariat alongside internationally recognized independent experts with extensive experience from a wide range of technical specialties from Argentina, Australia, Canada, China, France, the Marshall Islands, the Republic of Korea, the Russian Federation, the United Kingdom, the United States and Viet Nam. These independent experts provide advice to the IAEA and serve on the Task Force in their individual professional capacity to help ensure the IAEA's review is comprehensive, benefits from the best international expertise and includes a diverse range of technical viewpoints.

The IAEA primarily conducted its review through the analysis of documentation provided by TEPCO, NRA, and METI; and holding review missions to further clarify questions and to ask for additional materials. The IAEA also conducted onsite visits to FDNPS periodically throughout 2021, 2022, and 2023. Five review missions to Japan were carried out between February 2022 and June 2023 and these and the corresponding technical reports are detailed in Annex 1. The reports issued after the first four review missions serve as progress reports and final conclusions are only presented for the first time in this comprehensive report.

At the start of the review, the Government of Japan and TEPCO provided background materials with information pertaining to the proposed discharge of ALPS treated water. Subsequently, additional materials were provided upon request by the Task Force, or when ready for submission by TEPCO to the relevant Japanese authorities (e.g., NRA). This information was reviewed by the Task Force members and formed the basis for the review missions with relevant authorities. The purpose of the review missions was to review the reference materials submitted by the Government of Japan or TEPCO, seek clarification on technical issues, request additional information and observe on-site activities, as appropriate.

The IAEA has examined key safety elements of Japan's plan, including the following:

- The radiological characterization of the treated water to be discharged.
- The safety-related aspects of the treated water discharge process, including the equipment to be used and the criteria to be applied and observed for operations.

- The assessment of the radiological environmental impact related to ensuring the protection of people and the environment.
- The environmental monitoring associated with the discharge.
- The regulatory control, including authorization, inspection and ongoing assessment of the discharge plan.

The IAEA’s review (as shown in Figure 1.6) is organized into the following three major components to ensure all key safety elements are adequately addressed:

- **Assessment of Protection and Safety** – This component is focused on reviewing technical aspects of the Implementation Plan, radiological environmental impact assessment (REIA), and other supporting materials prepared by TEPCO as part of their submission for regulatory approval of the discharge of ALPS treated water. This component primarily involves TEPCO and the Ministry of Economy, Trade, and Industry (METI) and look at the expected actions to be performed by TEPCO throughout the process, as defined in the relevant IAEA international safety standards.
- **Regulatory Activities and Processes** – This component is focused on assessing whether the Nuclear Regulation Authority’s (NRA) review and approval process is conducted in accordance with the relevant IAEA international safety standards. This component primarily involves NRA as the independent regulatory body responsible for nuclear safety within Japan; it is focussed only on the regulatory aspects relevant for NRA’s review of the discharge of ALPS treated water from the Fukushima Daiichi Nuclear Power Station.
- **Independent Sampling, Data Corroboration and Analysis** – This component includes all activities associated with the IAEA’s independent sampling and analysis that is and will be performed to corroborate the data from TEPCO and the Government of Japan associated with the discharge of ALPS treated water. Samples are analysed by IAEA laboratories as well as independent third-party laboratories. Additionally, this component also includes the corroboration of occupational exposure.

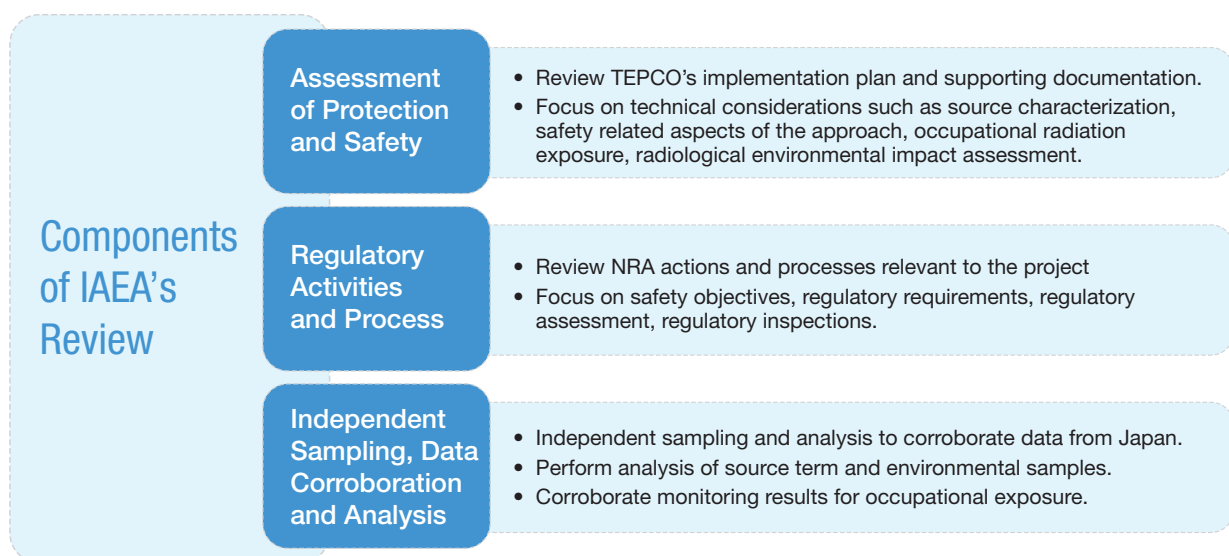

Figure 1.6. Components of the IAEA Review

Additional information on the IAEA’s review, as well as background information, documents, reports, and other publications can be found online at the dedicated website for the IAEA’s Fukushima ALPS review [5].

1.2. The Comprehensive Report

The purpose of this comprehensive report is to present the IAEA's final conclusions and findings from its technical review to assess whether the plan to discharge the ALPS treated water into the sea over the coming decades is consistent with the IAEA's international safety standards.

The scope of this report matches the scope of the IAEA's safety review, however additional background material regarding the history of the accident at the FDNPS and other associated details are also included. The IAEA's safety review is focused on assessing whether the actions of TEPCO and the Government of Japan to discharge the ALPS treated water over the coming decades is consistent with the international safety standards. Furthermore, the IAEA's review is focused on assessing whether Japan's chosen method for handling ALPS treated water (i.e., controlled discharges into the sea) is consistent with international safety standards and does not assess the feasibility of other potential methods. Finally, when necessary, explanations regarding the broader decommissioning effort were included in this report; however, in general, the site's comprehensive decommissioning activities were considered outside the scope of the IAEA's overall safety review.

The report consists of five parts:

- **Part 1** covers introduction and provides some background material on the source of the contaminated water, the ALPS treatment process, the facilities for discharging the ALPS treated water, the Japanese Basic Policy for handling the ALPS treated water, and the international safety standards.
- **Part 2** covers the assessment of consistency with the ten safety principles set out in the IAEA Safety Fundamentals, in a language that is understandable to all readers, as well as those with a non-technical background.
- **Part 3** covers the assessment of consistency of the discharge of ALPS treated water into the sea with the relevant Safety Requirements in the international safety standards. There are seven topics covered in the review are:
 - Characterization of the discharge and source term.
 - Safety related aspects of systems and processes for controlling discharges.
 - Radiological environmental impact assessment.
 - Regulatory control and authorization of discharges.
 - Source and environmental monitoring programmes.
 - Involvement of interested parties.
 - Occupational radiation protection.
- **Part 3** is written in technical language and describes the IAEA's review and assessment and sets out the conclusions of the assessment for each of these topics.
- **Part 4** covers the IAEA's corroboration activities to evaluate the accuracy of data provided by TEPCO and the Japanese authorities. The IAEA's independent sampling, data corroboration, and analysis activities are described in Part 4.
- **Part 5** includes additional information on the overall next steps the IAEA and the Task Force will take under the IAEA's safety review, which will continue for many years.

1.3. The IAEA international safety standards

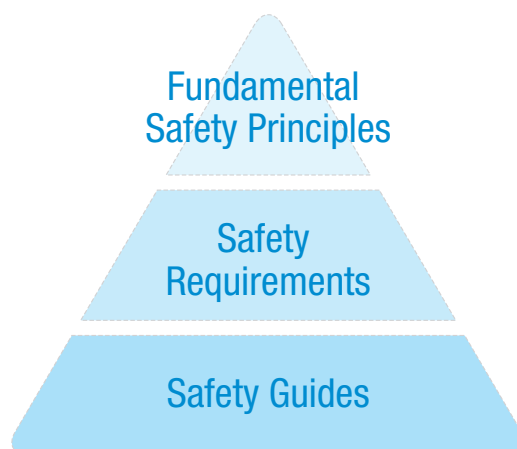

Figure 1.7. Hierarchy of IAEA Safety Standards

The relevant international safety standards are used as part of the IAEA's safety review (as detailed in Annex 2). These documents are standards of safety for protection of health and minimization of danger to life and property, including such standards for labour conditions. The IAEA's Safety Standards consist of three sets of publications: the Safety Fundamentals, the Safety Requirements and the Safety Guides. While the first one of these establishes the fundamental safety objective and principles of protection and safety, the second provide the requirements that must be met to ensure the protection of people and the environment, both now and in the future. The Safety Guides provide recommendations and guidance on how to meet the requirements. The international safety standards are cosponsored in consultation and, where appropriate, in collaboration with the competent organs of the United Nations and with the specialized agencies.

Safety Fundamentals

Safety Fundamentals present the fundamental safety objective and principles of protection and safety, and provide the basis for the safety requirements. The IAEA Safety Fundamentals are jointly sponsored by the European Atomic Energy Community (Euratom), the Food and Agriculture Organization of the United Nations (FAO), the International Atomic Energy Agency (IAEA), the International Labour Organization (ILO), the International Maritime Organization (IMO), the OECD Nuclear Energy Agency (OECD/NEA), the Pan American Health Organization (PAHO), the United Nations Environment Programme (UNEP) and the World Health Organization (WHO).

The ten Fundamental Safety Principles constitute the basis on which to establish safety requirements for the protection against exposure to ionizing radiation. The safety measures taken to ensure the protection of human life and health and the environment against exposure to radiation are detailed and technically complex. To the extent possible, however, the Fundamental Safety Principles have been drafted in language that is understandable to the non-specialist reader. The intention is to convey the basis and rationale for the safety standards for those at senior levels in government and regulatory bodies and those who, while responsible for making decisions concerning the uses of nuclear energy and radiation sources, may not be specialists in nuclear or radiation science and technology or in radiation protection and safety matters. The application of the Fundamental Safety Principles will facilitate greater consistency between the arrangements of different States and it is therefore desirable that all States adhere to and advocate these principles.

Safety Requirements

An integrated and consistent set of Safety Requirements establishes the requirements that must be met to ensure the protection of people and the environment, both now and in the future. The requirements are governed by the objective and principles of the Safety Fundamentals. If the requirements are not met, measures must be taken to reach or restore the required level of safety. The format and style of the requirements facilitate their use for the establishment, in a harmonized manner, of a national regulatory framework. Requirements, including numbered ‘overarching’ requirements, are expressed as ‘shall’ statements. Many requirements are not addressed to a specific party, the implication being that the appropriate parties are responsible for fulfilling them. Of particular relevance to the IAEA’s safety review, GSR Part 3: Radiation Protection and Safety of Radiation Sources: International Basic Safety Standards is jointly sponsored by European Commission, FAO, IAEA, ILO, OECD/NEA, PAHO, UNEP and the WHO.

Safety Guides

Safety Guides provide recommendations and guidance on how to comply with the safety requirements, indicating an international consensus that it is necessary to take the measures recommended (or equivalent alternative measures). The Safety Guides present international good practices, and increasingly they reflect best practices, to help users striving to achieve high levels of safety. Requirements, including numbered ‘overarching’ requirements, are expressed as ‘shall’ statements. Many requirements are not addressed to a specific party, the implication being that the appropriate parties are responsible for fulfilling them. The recommendations provided in Safety Guides are expressed as ‘should’ statements. Many IAEA Safety Guides relevant for this safety review are cosponsored by UNEP.

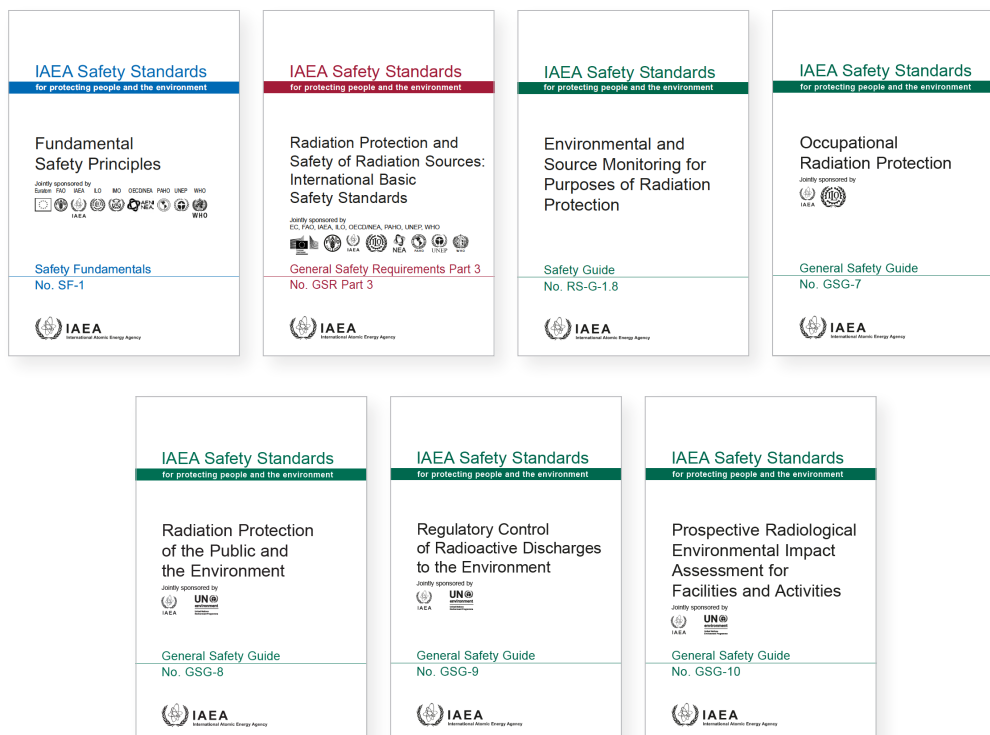

Figure 1.8. The International Safety Standards

Following a decision of the United Nations General Assembly (UNGA), the levels and effects of ionizing radiation are estimated by the United Nations Scientific Committee on the Effects of Atomic Radiation (UNSCEAR). The UNSCEAR estimates are provided yearly to UNGA and can be considered as the

scientific and epistemological basis of the International Safety Standards. Furthermore, an internationally recognized paradigm or model has been elaborated by the International Commission on Radiological Protection (ICRP) since its foundations in 1928. The ICRP is a non-governmental charity providing recommendations on radiation protection that has been followed by professionals, institutions and governments all over the world.

Following a formal decision of the IAEA intergovernmental policy making organs [6] the IAEA's Safety Standards are developed taking into account the recommendations of the ICRP; the latest general recommendations of ICRP can be found on their website and are published regularly.

PART 2

ASSESSMENT OF CONSISTENCY WITH THE FUNDAMENTAL SAFETY PRINCIPLES

The Safety Fundamentals state that the fundamental safety objective of protecting people — individually and collectively — and the environment has to be achieved without unduly limiting the operation of facilities or the conduct of activities that give rise to radiation risks. To ensure that facilities are operated, and activities conducted so as to achieve the highest standards of safety that can reasonably be achieved, measures have to be taken:

- To control the radiation exposure of people and the release of radioactive material to the environment.
- To restrict the likelihood of events that might lead to a loss of control over a nuclear reactor core, nuclear chain reaction, radioactive source or any other source of radiation.
- To mitigate the consequences of such events if they were to occur.

The fundamental safety objective applies for all facilities and activities, and for all stages over the lifetime of a facility or radiation source, including planning, siting, design, manufacturing, construction, commissioning, and operation, as well as decommissioning and closure. This includes the associated transport of radioactive material and management of radioactive waste.

Ten safety principles have been formulated, on the basis of which safety requirements are developed and safety measures are to be implemented in order to achieve the fundamental safety objective. The fundamental safety principles form a foundation that is applicable in its entirety, although in practice different principles may be more or less important in relation to particular circumstances.

Therefore, in order to verify that the fundamental safety objective was achieved, the Task Force considered how the ten fundamental safety principles applied to the discharge of the ALPS treated water. The Task Force discussed all ten fundamental safety principles to consider how the actions and plans of the Government of Japan and TEPCO addressed each.

2.1. Responsibility for Safety

The prime responsibility for safety must rest with the person or organization responsible for facilities and activities that give rise to radiation risks.

This principle states that the organization responsible for a facility that gives rise to radiation risks has the prime responsibility for safety. This responsibility cannot be delegated to another organization, although other organizations such as designers, manufacturers and constructors, and contractors, also have some responsibilities for safety, as their activities or products may be of significance for safety. However, the prime responsibility for safety cannot be delegated.

In Japan, the Atomic Energy Basic Act, the Reactor Regulation Act and the Radioisotope Regulation Act assign responsibilities for safety to licensees for all activities involving nuclear material and isotopes.

After the accident at FDNPS, the Reactor Regulation Act was amended to better reflect the prime responsibility for safety of the licensees. The Articles introduced require that licensees of nuclear power plants shall periodically re-evaluate the safety of their facilities and to improve the safety, to enhance education on operational safety, and to take any other necessary measures for preventing disasters.

In addition, in Article 6, paragraph (9) of the Supplementary Provisions of the NRA Establishment Act explicitly states that “Nuclear operators shall be deeply aware that they have prime responsibility for ensuring the safety of their nuclear facilities”. The responsibility for safety remains with the licensee when it contracts for products and services from third parties. None of the Acts in Japan allows the delegation of licensees’ responsibilities to other parties. Licensees are responsible for verifying that the products and services supplied to them by third parties comply with the applicable Law.

Based on its review of relevant documents and discussions held during meetings and missions, the Task Force has noted that TEPCO has the prime responsibility for safety for the management of the discharge of ALPS treated water at FDNPS and is licensed by NRA who is designated by the Government of Japan as having legal authority to conduct the regulatory process. TEPCO is responsible for ensuring the safety of the ALPS facility, and the associated equipment; establishing procedures and arrangements to maintain safety under all conditions; ensure the safe control of all radioactive material that is used and stored onsite; and provide adequate training and information to employees.

TEPCO has prepared an Implementation Plan [17] for activities at FDNPS, which includes the discharge of ALPS treated water. The Implementation Plan, which is reviewed and approved by the NRA, has supported the Task Force in better understanding a number of important technical points. Furthermore, the IAEA notes the following:

1. TEPCO has presented information on the radiological characterization of the treated water at various stages of the discharge process.
2. TEPCO has developed design criteria for the discharge facilities, that takes into account redundant and diverse safety features to detect and prevent events that could lead to the unintended release of ALPS treated water to the environment.
3. TEPCO has carried out a safety assessment for the discharge of ALPS treated water to the sea, in accordance with the requirements established by NRA.
4. TEPCO has carried out a radiological environmental impact assessment.
5. TEPCO is part of the Comprehensive Radiation Monitoring Programme [7] for the environmental monitoring associated with the discharge of ALPS treated water.

Conclusions

- Under the legal and regulatory framework established in Japan, TEPCO has the prime responsibility for the safety of the discharge of the ALPS treated water from FDNPS.

2.2. Role of the Government

An effective legal and governmental framework for safety, including an independent regulatory body, must be established and sustained.

This principle states that a properly established legal and governmental framework provides for the effective regulation of facilities and activities that give rise to radiation risks and for the clear assignment of responsibilities. The government is responsible for the development of legislation, regulations and other regulatory standards and guides that are necessary to fulfil its national responsibilities and international commitments for the regulatory control of facilities and activities that give rise to radiation risks, and for the establishment of an independent regulatory body. The regulatory body shall set up appropriate means of informing parties in the vicinity, the public and other interested parties, and the media about the safety aspects of facilities and activities, and about regulatory processes. The regulatory body shall also consult parties in the vicinity, the public and other interested parties in an open and inclusive process.

As a consequence of the accident at FDNPS, Japan fundamentally changed its regulatory system for nuclear safety and established the Nuclear Regulation Agency (NRA) as a new independent regulatory body. Under the NRA Establishment Act, NRA has sole responsibility for regulating nuclear safety, nuclear security, safeguards based on international commitments, and the use of radioactive isotopes and radiation monitoring. NRA engages in independent decision-making concerning regulatory activities, such as permits, approvals and inspections, without the involvement of the authorities tasked with promoting nuclear energy.

The NRA is an external bureau of the Ministry of the Environment, and therefore clearly separated from METI who holds jurisdiction over the promotion and use of nuclear energy.

The Chairman and Commissioners of NRA are appointed by the Prime Minister, with the consent of the Diet. The NRA Chairman appoints the staff of the Secretariat of NRA. The activities of NRA are financed by the national budget, with budget proposals being submitted to the Ministry of Finance by NRA. Authorities tasked with promoting nuclear energy are not involved in the approval process of the NRA budget.

The legislative and regulatory framework in Japan is based on a five-level system:

1. Basic Acts define the basic legal framework and policy for the safe use and regulatory oversight of nuclear energy and disaster control measures. The Basic Acts need to be approved by the national Diet.
 - a. In the area of nuclear safety, The Atomic Energy Basic Act is the most important piece of legislation. It defines the basic principles of nuclear energy use and safety, and the scope of the subsequent specific Acts.
 - b. The Basic Act on Disaster Control Measures, covering all types of disaster, defines the framework for emergency preparedness and response.

2. Acts implement the framework defined by the Basic Acts and form the main legal provisions for the development and utilization of nuclear energy, and the bases for safety regulation, authorization and inspection of nuclear facilities. Acts need to be approved by the national Diet.
 - a. The NRA Establishment Act stipulates NRA as a nuclear regulatory body and provides details on its authority and responsibilities.
 - b. The Reactor Regulation Act provides for regulations on all nuclear facilities and activities in order to protect the population and the environment from harmful effects of radioactivity and makes provision for regulations over controlled nuclear materials, as well as securing the use of nuclear energy for peaceful purposes.
 - c. The Radioisotope Regulation Act imposes regulations on the use, selling, rental, other handling of radionuclides, use of radiation generating apparatus, waste management and other handling of objects contaminated by radionuclides or radiation emitted from radiation generating apparatus.
 - d. The Nuclear Emergency Act stipulates the responsibility of nuclear operators, the procedure for declaring a nuclear emergency, the establishment of Nuclear Emergency Response Headquarters, and implementation of emergency response or other measures related to addressing nuclear emergency.
3. Cabinet Orders are issued by Cabinet and do not need to be approved by the national Diet. Cabinet Orders prescribe particulars entrusted by the Acts.
4. Ministerial Orders prescribe details as entrusted by the Acts. The NRA can issue Ministerial Orders in accordance with Article 26 of the NRA Establishment Act. Some of these Ordinances are also referred to as NRA Standards.
5. NRA Regulatory Guides provide further particulars or interpretation of the Ministerial Ordinances, acceptable methods, conditions etc.

NRA shared with the Task Force the information sharing and consultation processes that they have carried out in relation to the Implementation Plan. After TEPCO submitted amendments to the Implementation Plan to facilitate the discharge of ALPS treated water, the NRA and TEPCO participated in review meetings to discuss TEPCO's plans (see Annex 3 for a timeline of NRA review activities). These review meetings were open to the public, both for in-person attendance and via web-streaming. All materials, including minutes of the meetings are posted on the NRA website.

Additionally, the NRA provided an explanation in briefings for the National Diet, local governments, municipalities, press conferences, and international conferences, among others. The Task Force noted global interest in the discharge of ALPS treated water and the importance of providing evidence-based information to demonstrate protection of people and the environment globally. The NRA provided details regarding the public's involvement in the review of the Implementation Plan and REIA, noting that a large number of comments were received which were considered by NRA.

Conclusions

- The Government of Japan has established a legal and regulatory framework for facilities and activities that give rise to radiation risks, that includes the facilities and activities related to the discharge of ALPS treated water.

- NRA has been established an independent regulatory body, with responsibilities that include responsibility for the regulatory control of the TEPCO's facilities and activities for the discharge of ALPS treated water.
- NRA has carried out its regulatory responsibilities in relation to the discharge of ALPS treated water: NRA has required that TEPCO apply for a authorization to discharge ALPS treated water, NRA has reviewed documentation submitted by TEPCO in its application for a licence (e.g., safety assessment and REIA), and NRA is considering all available information as part of their regulatory authorization process before issuing an authorization to discharge the ALPS treated water.
- NRA has consulted with the public as part of its review of the Implementation Plan and REIA and comments were considered.
- NRA has established an information sharing program about its regulatory activities regarding the Implementation Plan and the REIA for people living in the vicinity, the public and other interested parties, that includes interested parties in neighbouring countries.

2.3. Leadership and Management for Safety

Effective leadership and management for safety must be established and sustained in organizations concerned with, and facilities and activities that give rise to, radiation risks.

This principle focusses on the effective leadership and management for safety in organizations concerned with facilities and activities that give rise to, radiation risks. This includes the organization responsible for the facility or for the activity and the regulatory body and other competent authorities.

The principle states that the management at all levels in these organizations shall demonstrate its commitment to the establishment, implementation, assessment and continual improvement of the organization's management system and shall allocate adequate resources to carry out these activities. Leadership for safety includes the organization's vision, goals, strategies, plans and objectives; by advocating for individual commitment to the protection of people and the environment from harmful effects of ionizing radiation, establishing behavioural expectations, and fostering a strong safety culture. Management for safety includes establishing and applying an effective management process.

The leadership and management for safety are therefore of fundamental importance for the organizations that have responsibilities relating to the discharge of ALPS treated water. However, the Task Force has also acknowledged that the discharge of ALPS treated water is occurring within the larger FDNPS and therefore falls under broader leadership and management structures at TEPCO and at NRA.

TEPCO's organizational structure indicates that the ALPS Treated Water Program Department is responsible for the development implementation of relevant oversight, planning, and technical aspects of the ALPS treated water discharge facilities. There are other supporting technical Departments in several fields such as construction, maintenance, engineering, installations, training and monitoring laboratories.

NRA's management system documents the work processes of NRA, including the regulatory processes for authorization and inspection. NRA subjects its management system to internal audits to ensure it

remains compliant with its rules and to identify opportunities for improvement, e.g. proposals made by NRA employees. NRA has organized staff seminars on safety culture and promotes the need for staff to recognize the need to promote safety culture, based on the recommendations of the accident investigation committees of Fukushima-Daiichi NPP.

This principle also states that safety has to be assessed for all facilities and activities. A safety assessment involves the systematic analysis of normal operation and its effects, of the ways in which failures might occur and of the consequences of such failures. A facility can only be constructed and commissioned, or an activity may only begin once it has been demonstrated, to the satisfaction of the regulatory body, that the proposed safety measures are adequate.

The Task Force highlighted the significant amount, and level of detail, of analyses performed by TEPCO for the conduct of the safety assessment, its comprehensive approach, as well as the fact that a large number of potential single failure events were taken into consideration for the development of the design criteria for the discharge of ALPS treated water. In addition, the Task Force mentioned during previous missions, the importance of making a comprehensive assessment considering all failure modes and identifying the different initiators that might lead to the discharge of undiluted ALPS treated water; the work done documented in the implementation plan. Further details about the safety assessment can be found in Part 3 (Section 3.2).

Conclusions

- Leadership and management for safety within TEPCO and NRA has been established.
- Management for safety includes the elements that take into account the safety culture.
- Considering the period duration of the discharge of ALPS treated water, the feedback of operating experience from all involved structure, systems, and components including the results of source term and environmental monitoring and their analysis is a key means of enhancing safety.

2.4. Justification

Facilities and activities that give rise to radiation risks must yield an overall benefit.

Justification is a fundamental principle for the international standards of Radiation protection. It considers that activities giving rise to radiation risks must yield an overall benefit, namely that any decision that alters the radiation exposure situation should do more good than harm. In accordance with GSR Part 3 [8], “*the government or the regulatory body, as appropriate, shall ensure that provision is made for the justification of any type of practice and for review of the justification, as necessary, and shall ensure that only justified practices are authorized*”.

In paragraph 2.11, GSG-8 [10] states that “*For planned exposure situations, justification is the process of determining whether a practice is, overall, beneficial, i.e. whether the expected benefits to individuals and to society from introducing or continuing the practice outweigh the harm (including radiation detriment) resulting from the practice. The benefits apply to individuals and society as a whole, and include benefits to the environment. Radiation detriment may only be a small part of the total harm. Justification thus goes*

far beyond the scope of radiation protection, and also involves the consideration of economic, societal and environmental factors.”

The request of the Government of Japan to the IAEA to review the application of relevant international safety standards to the discharge of ALPS treated water into the sea was submitted after the Government’s decision was made. Therefore, the scope of the current IAEA safety review did not include an assessment of the details of the justification process followed by the Government of Japan. However, the IAEA notes that based on the historical details made public by the Government of Japan (see Part 1), and the involvement of the IAEA in other decommissioning work at FDNPS, a decision-making process was followed by the Government of Japan and which justified the final choice of how to manage the ALPS treated water stored at FDNPS. Additionally, throughout the IAEA’s review, it was acknowledged that the TEPCO’s application based on the approach identified by the Government of Japan was reviewed and approved by the regulatory body, NRA.

The Government of Japan has the final decision-making authority to determine how to handle the treated water, and how that decision is justified. Notwithstanding, the justification of the final choice of how to manage the ALPS treated water stored at FDNPS is extremely relevant for many stakeholders and merits a clear explanation from the Government of Japan. This explanation is provided in the Basic Policy published by the Government of Japan in April 2021 and through further explanations and clarifications provided to interested parties. Throughout the IAEA’s review, the Task Force frequently highlighted the importance of clear, frequent, and relevant communication with interested parties about the planned discharge.

It is important to mention that the justification decision goes far beyond the scope of radiation protection, and also involves other considerations, many of which are not technical in nature, such as economic and societal factors and therefore it is not for the IAEA to comment on and analyse the non-technical aspects of this decision.

The IAEA also notes that where expected exposures are low, factors other than radiation safety (e.g., economic, societal) may become more important and can drive the decision-making process.

Furthermore, GSG-9 [9] states that “Justification applies to the overall practice and not to individual aspects of the practice ...” Therefore, it is clear that the issue of justification of the discharge of ALPS treated water is inherently linked with the overall justification of the decommissioning activities taking place at the FDNPS and thus is influenced by broader and more complex considerations. Decisions regarding justification should be taken at a sufficiently high governmental level to enable all the considerations that may be related to the benefits and detriments to be taken into account. As nuclear safety is a national responsibility, it is a decision for the Government of Japan to take.

Conclusions

- The responsibility for justifying the decision to discharge the ALPS treated water falls to the Government of Japan.
- The IAEA notes that the Government of Japan has followed a decision-making process leading to the justification of its approach.

2.5. Optimization of Protection

Protection must be optimized to provide the highest level of safety that can reasonably be achieved.

A fundamental principle of the international safety standards is that the protection against exposure to ionizing radiation must be optimized to provide the highest level of safety that can reasonably be achieved taking into account relevant economic, social, and other factors.

Safety measures that are applied to the discharge of the ALPS treated water need to be optimized to provide the highest level of safety that can reasonably be achieved throughout the lifetime of the activity. Various factors influencing optimization of protection, include: the number of people (workers and the public) who may be exposed to radiation; the likelihood of their incurring exposures; the magnitude and distribution of radiation doses received; radiation risks arising from foreseeable events; and economic, social and environmental factors.

The Task Force discussed with the Government of Japan the importance of the requirement on optimization of protection, included in the relevant international safety standards, in the Japanese regulatory framework. The Task Force noted that the *Basic Policy on Handling of ALPS Treated Water at the Tokyo Electric Power Company Holdings' Fukushima Daiichi Nuclear Power Station* notes that "...[the] discharge of ALPS treated water into the sea will be implemented at FDNPS, on the premise to make best efforts to minimize the risks by taking measures such as purification and dilution based on the ALARA principle, under strict control." ALARA which stands for "as low as reasonably achievable" refers to the concept of making every reasonable effort to keep exposures to ionizing radiation as low as practicable considering relevant societal, economic, and other considerations.

The relevant international safety standards require the establishment of *dose constraints* as part of the process for optimization of protection for any planned exposure situation. For the discharge of the ALPS treated water, the establishment of a prospective and discharge-related restriction on the individual dose attributable to the discharge, provides a basic level of protection for the most highly exposed individuals due to the discharge, and serves as an upper bound on the dose in the optimization of protection for the discharge.

Representative Person

The representative person is defined as "An individual receiving a dose that is representative of the doses to the more highly exposed individuals in the population". The representative person will generally be a hypothetical construct and not an actual member of the population. The concept is used to determine compliance or in prospective assessments. [10]

In accordance with paragraph 5.32 of GSG-10 [11], the dose to the representative person should be calculated using characteristics selected from a group of individuals representative of those more highly exposed in the population. GSG-10 explains that the characteristics of the representative person should be specified by the applicant in accordance with national regulations and in agreement with the regulatory body.

NRA selected a dose constraint of 0.05 mSv in a year to the representative person for the discharge of ALPS treated water. Refer to Part 3 (Section 3.1) for additional information on the relevant dose criterion set by NRA. It was subsequently used in the process for optimization of protection, the intended outcome of which being that all exposures are controlled to levels that are as low as reasonably achievable, taking into account economic, societal and environmental factors. The selected dose constraint is applied to the public exposure attributable to the discharge of the ALPS treated water. It serves as a boundary condition in defining the range of options for the purpose of optimization of protection.

The IAEA notes that dose constraints are not dose limits (see fundamental safety principle 6: limitation of risk to individuals) in the international safety standards: exceeding a dose constraint does not represent non-compliance with regulatory requirements, but it could result in follow-up actions.

TEPCO carried out a radiological environmental impact assessment (REIA) to estimate the dose to the representative person resulting from the discharges of ALPS treated water and to evaluate the compliance with the dose constraint of 0.05 mSv in a year. The process carried out by TEPCO for the elaboration of the REIA is consistent with relevant international safety standards. Further detailed information regarding the REIA can be found in Part 3 (Section 3.4).

Dose

Several different terms exist relating to the measurement and reporting of “radiation dose”. Dose is defined as “*A measure of the energy deposited by radiation in a target.*” This concept is used when considering how ionizing radiation impacts people. There are many different dose concepts that are important to understand such as:

- **Absorbed dose** is the fundamental dosimetric quantity. It is the total energy deposited by ionizing radiation in a given volume of tissue divided by the mass of that tissue. The unit of absorbed dose is joules per kilogram and given the name Gray (Gy).
- **Effective dose** is the absorbed dose multiplied by a radiation weighting factor (w_R) for the type of radiation and a tissue weighting factor (w_T) that reflects the relative sensitivities of organs and tissues. The unit of effective dose is the Sievert (Sv).
- **Committed effective dose** is the sum of the effective dose from external exposure and the effective dose from intakes of radionuclides (i.e., from internal exposure by ingestion and inhalation).

For the purposes of calculating the dose from intakes of radionuclides into the body, an adult is assumed to be age 20, at the time of intake and the dose calculated is the radiation dose to the body over a period of 50 years (i.e., a committed dose to age 70). Children are assumed to be age 10 and infants are assumed to be age 1 at the time of intake; the committed radiation dose to the body being calculated for 60 years and 69 years, respectively (i.e., to age 70).

The committed effective dose is the calculated dose in the REIA.

Since the assessment was conducted based on conservative assumptions, there is no significant risk of underestimation. Any person living in the wider area would be far less affected by exposure than the representative person identified in the REIA.

The REIA [15] provides an estimate of the committed effective dose to the representative person (for adult, child and an infant), ranging from 0.000002 (2E-06) to 0.00004 (4E-05) mSv/year. The results were much

smaller than the dose constraint of 0.05 mSv per year. Furthermore, the results are significantly below the accepted 0.01 mSv threshold below which it is usually not recommended to conduct optimization. These results are largely due to the limits set by the Government of Japan for the discharge of ALPS treated water both in terms of tritium concentration and annual discharge limit for tritium. In order to minimize the impact on the surrounding environment and the reputational damage, Japan has set a maximum tritium concentration (1,500 Bq/L) for the discharge and a total annual tritium discharge limit (22 TBq per year).

The IAEA understands that discharge limits set in government policy were influenced by a wide range of prevailing circumstances, such as societal concerns and a desire to reduce the overall radioactivity being released to the environment. The Task Force acknowledges that these could be considered as key factors that informed the optimization process.

Conclusions

- The NRA established requirements for the optimization of protection and subsequently enforced them.
- TEPCO has ensured that the optimization of protection and safety has been considered, taking into account the prevailing circumstances.
- IAEA considers that if there is any decision to change parameters related to the discharge in the future, further studies looking at the optimization of protection should be conducted and evaluated.

Dose Constraints

A dose constraint should be expressed in terms of the annual effective dose and is established for each source – each planned operation or activity, including the authorized discharge of radioactivity – that may contribute to the exposure of the public.

As stated in Paragraph 5.15 of GSG-9 [9], “The dose constraint for each particular source is intended, among other things, to ensure that the sum of doses from planned operations of that source and of all the authorized sources that may contribute to the exposure of the public remains within the dose limit”, which is 1 mSv per year as stated in GSR Part 3 [8]. A dose constraint should also be higher than a dose of the order of 0.1 mSv in a year. Therefore, in practical terms, dose constraints should be selected within the range of 0.1 to less than 1 mSv in a year, taking into account the characteristics of the site and of the facility or activity, the scenarios for exposure and the views of interested parties.

Dose constraints serve as boundary conditions when defining options for protecting people and the environment from the harmful effects of ionising radiation. As such, dose constraints are the starting point for optimization of protection and safety.

After exposures have occurred, the dose constraint may be used as a benchmark for assessing the suitability of the strategy for protection and safety (referred to as the protection strategy) that has been implemented and for adjusting the strategy as necessary.

2.6. Limitation of Risks to Individuals

Measures for controlling radiation risks must ensure that no individual bears an unacceptable risk of harm.

This fundamental safety principle requires that measures for controlling radiation risks must ensure no individual bears an unacceptable risk of harm. The principles of justification and optimization are fundamental to enhancing radiation protection. But justification and optimization of protection do not in themselves guarantee that no individual bears an unacceptable risk of harm. Consequently, doses and radiation risks must be controlled within specified limits that represent the judgement of the regulatory body (or other Government authorities) as to what constitutes an acceptable risk.

This fundamental safety principle is implemented, in practice, using dose limits which represent a legal upper bound of acceptability for the relevant approving authority. ICRP has recommended dose limits, and these are incorporated into the relevant international safety standards. The NRA established dose limits for public exposure to be applied by TEPCO which are consistent with what is included in the international safety standards and recommended by ICRP. These dose limits apply to the sum of the relevant doses from external exposure in a year and the relevant committed doses from intakes in a year; the period for calculating the committed dose for adults shall normally be 50 years from intake and shall be up to 69 years for intakes by infants (i.e., up to age 70).

As noted under fundamental safety principle 5, Optimization of Protection, TEPCO carried out a radiological environmental impact assessment (REIA) to estimate the dose to the public due to the discharges resulting from ALPS treated water. The process carried out by TEPCO for the elaboration of the REIA is in line with the international safety standards. The REIA considered the characterization of the source of radiation as it relates to public exposure, the dispersion, and the transfer of radionuclides in the environment for identified exposure pathways and the external exposure and internal irradiation.

The REIA provides an estimate of the committed effective dose to the representative person (for adult, child and an infant), ranging from 0.000002 (2E-06) to 0.00004 (4E-05) mSv/year. The results were well below the dose limit of 1 mSv/year for the general public and the dose constraint of 0.05 mSv/year.

Potential Exposure

The definition of “potential exposure” in the international safety standards is “Prospectively considered exposure that is not expected to be delivered with certainty but that may result from an anticipated operational occurrence or accident at a source or owing to an event or sequence of events of a probabilistic nature, including equipment failures and operating errors.”

As part of the safety assessment required to be carried out for facilities and activities, various types of accident are postulated in order to identify engineered safety features and operational actions to reduce their likelihood and, if an accident does occur, to mitigate its consequences. This analysis determines if adequate defence in depth has been achieved and gives insights into the probability of various accident scenarios, taking into account the safety measures in place and their effectiveness. The potential exposures of members of the public are assessed using these accident scenarios. [11]

Within the REIA, the assessment of potential exposures has been made and estimates of dose to members of the public resulting from postulated accident scenarios identified through the safety assessment

estimated. The potential exposure scenarios include the characteristics of the events or sequences of events that may lead to any unintended exposure. The associated source term, the modelling of direct irradiation, the dispersion and transfer of radionuclides in the environment, identification of the relevant exposure pathways to the representative person for potential exposures and the assessment of the dose to the representative person were considered. The environmental dispersion and transfer are estimated with relevant models, considering the defined environmental conditions, on the basis of meteorological and oceanographic data.

Based on the above, TEPCO assessed the potential exposures of members of the public in its REIA, assuming two accident scenarios: one where about 10,000 m³ of undiluted treated water leaks from 1 tank group into the sea accidentally over 20 days, and one where about 30,000 m³ of undiluted treated water is accidentally discharged over one day from 3 tank groups.

The dose calculated for the adult representative person is in the range of 0.0002 (2E-04) mSv to 0.01(1E-02) mSv for the 2 accident scenarios considered. In both scenarios, TEPCO conservatively assessed all exposure pathways, and confirmed that the exposure of the representative person living near the power plant would be well below 5 mSv per event, which is the established in the international safety standards in the event of an accident.

Results and Verification of Compliance with the international safety standards

Radiological Impact Assessment	International Safety Standards Criteria	Assessment results for representative person (adult) due to discharge of ALPS treated water
Radiological impact on humans in normal operations	Dose limit for public 1 mSv / year	0.000002 - 0.00003 mSv/year
Radiological impact in case of potential exposure	Typically 5 mSv/event	0.0002 to 0.01 mSv/event

Conclusions

- The results of the impact of the discharge treated water on humans are consistent with the international safety standards.
- The radiological impact assessment of the discharge into the sea on humans in normal operation and in case of potential exposures is below the dose constraints and the dose limit for members of the public established at the international safety standards.
- All assumptions for the selected potential exposure cases are conservative.

2.7. Protection of Present and Future Generations and their Environment

People and the environment, present and future, must be protected against radiation risks.

The protection of future generations and the environment is an important concept that is, embedded in the concepts of justification, optimization and the limitation of risk to the individual. Nonetheless, it is presented separately in the international safety standards. This fundamental safety principle simply requires that people and the environment, present and future, must be protected against radiation risks.

As part of its activities, the Government of Japan and TEPCO must take into account that radiation risks attributable to the discharge might transcend national borders and may persist for long periods of time. Thus, the measures to control the discharges consider any possible consequence, now and in the future. In particular, it is important to note that the international safety standards apply not only to local populations but also to populations remote from the discharge activities; and that where effects could span generations, subsequent generations have to be adequately protected without any need for them to take significant protective actions.

This is an important fundamental safety principle given the long-term approach currently envisaged for discharging ALPS treated water at FDNPS. Through its work the IAEA has noted that the REIA produced by TEPCO and reviewed by NRA has demonstrated that the dose to representative persons in neighbouring countries will be undetectable and negligible.

In order to ensure the proper protection of future generation, the Task Force decided to corroborate that the dose commitment, rather than the dose incurred, is the fundamental quantity for determining compliance with the international safety standards. The fundamental quantity for assessing doses shall be the dose due to external exposure in a year plus the committed dose from intakes of radionuclides in that year. This means that the total annual dose calculated is that received over a lifetime (assumed to be until the age of 70) from intakes of radionuclides due to the ALPS treated water that is discharged to the sea in an assigned year.

It should be noted that the total amount of tritium, ^{14}C and ^{129}I to be released each year in the discharge of ALPS treated water will be well below the amount of these radionuclides produced by natural processes each year, such as interaction of cosmic rays with gases in the upper atmosphere.

Production of ^3H , ^{14}C and ^{129}I by natural processes

There are three main sources of natural tritium on earth: production in the atmosphere by cosmic rays; production in the atmosphere by energetic particles originated from solar coronal mass ejections; and direct accretion from the sun. Tritium produced by natural processes on earth is rapidly converted into HTO, which then enters the global hydrological cycle. The annual production of tritium due to natural processes is estimated to be around 280 grams, with annual production varying between 220 to 330 grams due to the variation in the intensity of cosmic due to the solar cycle variations.

The average value of 280 grams in a year corresponds to the activity in the order of 100 PBq (100,000 TBq) in a year. The global inventory of tritium is estimated to be about 2,000 PBq (2,000,000 TBq). The limit on the amount of tritium in the treated water to be released each year is 22 TBq. This is about 5,000

times lower than the annual production on the planet due to natural processes, and much less than the variation from year to year in the annual production.

The tritium natural background level in the Pacific Ocean is in the range of 0.1-1 Bq/L. The ocean dispersion modelling conducted by TEPCO indicates that concentrations of tritium above natural background concentrations will be limited to within 3 km of the discharge point at FDNPS. The concentration is much lower than the natural background level at the boundary of the model simulation range (490 km x 270 km), the maximum value being 0.00026 Bq/L, which is three to four orders of magnitude lower than the natural background level.

The main source of natural ^{14}C on earth is the production in the atmosphere by cosmic rays by the nuclear reaction: $^{14}\text{N}(n, p)^{14}\text{C}$. The global inventory due to natural processes of ^{14}C is estimated to be around 1 PBq (1,000 TBq). The amount of ^{14}C in the ALPS treated water to be released each year is about 2 GBq (0.002 TBq), which is about 500,000 times lower than the global inventory due to natural processes.

Iodine-129 is produced by the following natural processes: reactions of cosmic rays with xenon in the upper atmosphere; spontaneous fission of ^{238}U ; thermal neutron induced fission of ^{235}U ; and neutron activation reactions $^{128}\text{Te}(n,\gamma)^{129}\text{I}$ and $^{130}\text{Te}(n,2n)^{129}\text{I}$. It is estimated that the global inventory of ^{129}I due to natural processes in the hydrosphere (primarily oceans) is about 1 TBq. The amount of ^{129}I to be released in the treated water each year is 30-300 MBq. This is about 3,000-30,000 times lower than the steady state inventory of naturally occurring ^{129}I in all of the oceans.

The Task Force has also considered that whereas the effects of radiation exposure on human health are relatively well understood, albeit with uncertainties, the effects of radiation on the environment are under continuous investigation by science. The system of radiation protection established by the international safety standards provides appropriate protection of ecosystems in the human environment against harmful effects of radiation exposure. The general intent of the measures taken for the purposes of environmental protection has been to protect ecosystems against radiation exposure that would have adverse consequences for populations of a species, rather than focusing on individual organisms.

Protection of the Environment

The environment is defined in the international safety standards as “The conditions under which people, animals and plants live or develop and which sustains all life and development, especially such conditions as affected by human activities”

Protection of the environment is defined as “Protection and conservation of non-human species, both animal and plant, and their biodiversity; environmental goods and services, such as the production of food and feed; resources used in agriculture, forestry, fisheries and tourism; amenities used in spiritual, cultural and recreational activities; media, such as soil, water and air; and natural processes, such as carbon, nitrogen and water cycles.

The high-level aim of the protection of the environment set by the ICRP is to provide for the maintenance of biological diversity and to ensure the conservation of species and the health of natural habitats, communities, and ecosystems. The radiation risk to populations of flora and fauna are expected to be negligible. The methods used for the assessment of the impact on flora and fauna are based on the current scientific knowledge of radiation effects.

The IAEA international safety standards are in agreement with the international environmental protection objectives of maintaining biological diversity, ensuring the conservation of species, and protecting the health and status of natural habitats, communities, and ecosystems.

TEPCO followed a methodology for assessing the impact on flora and fauna provided in the international safety standards that is in line with the ICRP approach for the protection of different ecosystems in the environment. Consistent with this approach, three species are used as references for the protection of the marine environment. The conceptual approach is that, if the criteria for those three reference species is not exceeded, then all the species can be assumed to be equally well protected, at the level of their populations (particularly for planned exposure situation). The three reference species are:

- Flat fish (Left-eyed and right-eyed flounders widely inhabit the sea area around the FDNPS)
- Crabs (*Ovalipes punctatus* and *Portunus trituberculatus* widely inhabit the sea area around the FDNPS)
- Brown seaweeds (*Sargassum* and *Eisenia bicyclis* widely inhabit the sea area around the FDNPS)

These plants and animals are widely distributed in the sea area around the FDNPS, so the radioactive material concentration in the seawater used for the assessment is for a reference area around the discharge point where the highest environmental activity concentrations typically occur line with the generic methodology in the international safety standards. For further details refer to Part 3 (Section 3.4). In addition, in the assessment of dose rates to plants and animals, external exposure is calculated from radionuclides seabed sediments, as well as those suspended in the seawater, to take account of fish that live on the seabed (reference flatfish).

The exposure results are for Flatfish 0.0000007 (0.7 E-06) mGy per day, for Crab 0.0000007 (0.7E-06) mGy per day and for Brown seaweed of 0.0000008 (0.8 E-06) mGy per day. These values are well below the Derived Consideration Reference Level (DCRL) provided as an example in the international safety standards and established by ICRP.

Radiological Impact Assessment on animals and plants in the sea	International Safety Standards	Assessment results
Flatfish	1-10 mGy/day	0.7×10^{-6} mGy/day
Crab	10-100 mGy/day	0.7×10^{-6} mGy/day
Brown seaweed	1-10 mGy/day	0.8×10^{-6} mGy/day

While the Task Force is aware that the behaviour of radioactive substances in the environment is complex, it holds the view that the requirements of the international standards on environmental protection have been respected and that radiation exposure to the biota attributable to the discharge will not be expected to be a noteworthy consideration in meeting these objectives. The Task Force also underline its concurrence with the international consensus, expressed in ICRP recommendations, that the standards of control of discharges (planned exposures) needed to protect the general public, which are being fully applied to the discharges, would generally ensure that other species are not put at risk.

The IAEA is confident that the international environmental protections objectives will be amply met by the controls in place for the discharge of ALPS treated water and that the dose rates to biota are negligible compared to the international safety criteria set by ICRP.

In summary, the discharge of the water must be managed to protect future generations and their environments in such a way as to avoid imposing an undue or uncontrolled burden on future generations. TEPCO must apply safe, practicable, and environmentally acceptable solutions for its long-term management of ALPS treated water. The IAEA notes that the existing assessment and controls conducted for the planned discharge of ALPS treated water from FDNPS appear to satisfy this principle.

Conclusions

- TEPCO has carried out a REIA for the discharge of the ALPS treated water, in line with the international safety standards.
- An assessment of the radiation dose to the public considering all situations, and an assessment of the radiation dose rates to marine animals and plants in normal operation was carried out.
- It also has been confirmed that the evaluation result of radiological impact on animals and plants in the sea by the discharge of ALPS treated water under normal operations is negligible.
- The results of the radiological environmental impact assessment show that the estimated dose to populations in neighbouring countries will be negligible.
- TEPCO's marine dispersion models predict very insignificant concentrations of tritium and other radionuclides that will be undetectable or indistinguishable from background levels at the boundary of the modelling simulation area.

Derived Consideration Reference Level

The ICRP has defined criteria for assessing and managing the radiological impact on animals and plants in the form of “derived consideration reference levels” [12]. Derived consideration reference levels span one order of magnitude; for dose rates below the lower bound of the bands, no effects have been observed or no information on effects is available.

Derived consideration reference levels do not represent limits; rather, in accordance with ICRP recommendations [12] they should be considered as points of reference for informing the appropriate level of effort that should be expended on environmental protection, dependent on the overall management objectives, the actual flora and fauna present, and the number of individuals exposed [12, 13].

2.8. Prevention of Accidents

All practical efforts must be made to prevent and mitigate nuclear or radiation accidents.

This fundamental safety principle refers to the application of good engineering practices and practicable measures to prevent accidents and to mitigate the consequences of those accidents that do occur. In particular, the siting, location, installation design, construction, commissioning, operation, maintenance, or closure of the facility should be based on good engineering practice taking into account international and national standards.

These activities also need to be supported by managerial and organizational features to ensure protection and safety throughout the lifetime of the facility, safety margins in the design and construction and take account of the necessary quality, redundancy, and capability for inspection, with emphasis on preventing accidents, mitigating the consequences of those accidents that do occur and restricting any possible future exposures.

Therefore, it is necessary to ensure that a multilevel (defence in depth) system of sequential, independent provisions for protection and safety that is commensurate with the likelihood and magnitude of potential exposures is applied. In this regard, the concept of a “graded approach” should be applied by the operator

and regulatory body to ensure that the measures applied to protect against any potential accidents are clearly in line with the potential for harm to members of the public. In its analysis, the worst-case scenario identified by TEPCO, requiring controls for mitigation, was the unintended release of ALPS treated water from the site. The impacts from this unintended release, which are negligible, are further discussed in fundamental safety principle 6 and Part 3 (Section 3.4).

For the IAEA's safety review, the various engineered controls, facilities, procedures, and other safety features were considered by the Task Force, and it was noted that the systems and processes in place to control the discharges of ALPS treated water are appropriate for this application. The inclusions of engineered controls to ensure that unintended discharges of ALPS treated water don't occur, and the processes and measurement steps in place to ensure that the discharged water is appropriately diluted to meet the regulatory requirements, all ensure that sufficient control is in place to protect against and mitigate the effects from accidents. Part 3 (Section 3.2) of this report includes further information about how the systems and processes for safety were assessed.

In addition, the Task Force noted the importance of compliance with the maintenance plan, inspection programmes, and testing planned before and during the discharge of the ALPS-treated water.

Conclusions

- Sound engineering design and procedural controls for safety were applied by TEPCO to control the process and to avoid the unintentional discharge of ALPS treated water.
- Redundancy was built into the system for some components, such as emergency isolation valves and detectors, ensuring the concept of “defence-in-depth” was incorporated.

2.9. Emergency Preparedness and Response

Arrangements must be made for emergency preparedness and response for nuclear or radiation incidents.

The goal of emergency preparedness is to ensure that an adequate capability is in place within the operating organization and at local, regional and national levels and, where appropriate, at the international level, for an effective response in a nuclear or radiological emergency. This capability relates to an integrated set of infrastructural elements that include but are not limited to: authority and responsibilities; organization and staffing; coordination; plans and procedures; tools, equipment and facilities; training, drills and exercises; and a management system. In meeting this principle, it should be noted that the Government of Japan is a contracting party of the Convention on Early Notification of a Nuclear Accident.

According with the Atomic Energy Basic Act, a Nuclear Emergency Preparedness Council was established within the Cabinet, with the Prime Minister serving as the Chairperson and the Chief Cabinet Secretary, the Minister of the Environment, other Minister(s) of State appointed by the Prime Minister, and the NRA (Nuclear Regulation Authority) Chairman serving as Vice Chairpersons. The Nuclear Emergency Act includes all measures to prevent nuclear disasters and strengthened the functions of the Nuclear Emergency

Response Headquarters in any emergency. The NRA formulates specialized and technical guidelines to implement emergency preparedness measures, emergency response and the restoration from emergency.

The NRA EPR Guide was formulated, and the Emergency Planning Zone, the Emergency Action Level (EAL), the Operational Intervention Level (OIL) and other such matters were established. Off site response measures, include the division of roles between the national and local governments, the emergency radiation monitoring system and the medical treatment system in a nuclear disaster. On-site, appropriate alarm systems and equipment for communication are provided so that proper directions may be provided to everyone in the Specified Nuclear Facility in case of an accident. Equipment for communication between the Specified Nuclear Facility and off-site locations is also provided, with redundancy and diversity of systems considered in the implementation of these measures.

The safety assessment carried out by TEPCO for the ALPS treated water project has identified possible abnormal events and external events. Two events that could lead to an uncontrolled release of the ALPS treated water from the measurement and confirmation tanks were considered. For the scenario giving rise to the highest doses of the two scenarios (accidental discharge to sea of about 30,000 m³ of undiluted treated water from the tanks in one day), the potential exposure calculated for the adult representative person is 0.0002 (2E-04) mSv to 0.01(1E-02) mSv. This demonstrates that the radiation risks from such an event are negligible and far below what is suggested in international safety standards. While the discharge of ALPS treated water falls under the broader emergency and response provisions for the FDNPS, no specific measures beyond the controls put in place as discussed in Part 3 are envisaged.

Conclusions

- Japan has an integrated and coordinated emergency system for preparedness and response for any radiological emergency as part of the national emergency system including the decommissioning of FDNPS.
- The emergency preparedness and response arrangements including the roles and responsibilities are in place for an effective response at the scene and, as appropriate, at the local, regional, national and international levels.
- For the potential incidents and events associated with the discharge of ALPS treated water that have been considered, radiation risks would be insignificant and would not necessitate response measures.
- In general the legal framework is in place for EPR and the FDNPS complies with those requirements.
- With regard to ALPS treated water discharge, no radiological emergency is anticipated.

2.10. Protective Actions to Reduce Existing Radiation Risks

Protective actions to reduce existing or unregulated radiation risks must be justified and optimized.

The last fundamental safety principle refers to protective actions to reduce existing or unregulated radiation risks. The IAEA safety fundamentals principles publication provides examples of situations where the fundamental safety principle for existing exposure situations would be applicable. These include:

- (i) those situations concerning radiation exposure of essentially natural origin, for example, exposure due to radon in dwellings,
- (ii) those situations concerning extant exposure situations that arises from human activities conducted in the past that were never subject to regulatory control, or that were subject to a non-rigorous regime of control; and,
- (iii) those following remediation measures taken following an uncontrolled release of radionuclides to the environment.

The discharge of the ALPS treated water does not fall into any of these situations. The radiation risk that might be attributed to the discharge of ALPS treated water are subject to review by NRA, as a planned exposure situation. This safety principle is therefore not applicable to the discharge of ALPS treated water. However it is important to note that other relevant international safety standards still apply and are covered in detail throughout this report.

Conclusions

- The FDNPS is managed as an existing exposure situation in the Japanese regulatory framework; however the discharges of ALPS treated water into the sea, which are controlled discharges, are viewed as a planned exposure situation by NRA, consistent with relevant international safety standards. Therefore, these discharges should conform to the international safety standards applied to planned exposure situations and thus this fundamental safety principle is not applicable to the discharge of ALPS treated water.

Types of exposure situation

The international safety standards distinguish between three different types of exposure situation [8]:

- A planned exposure situation is a situation of exposure that arises from the planned operation of a source or from a planned activity that results in an exposure due to a source.
 - An emergency exposure situation is a situation of exposure that arises as a result of an accident, a malicious act or any other unexpected event, and requires prompt action in order to avoid or to reduce adverse consequences.
 - An existing exposure situation is a situation of exposure that already exists when a decision on the need for control needs to be taken. Existing exposure situations include situations of exposure to natural background radiation.
-

PART 3

ASSESSMENT OF CONSISTENCY WITH SAFETY REQUIREMENTS

3.1. Regulatory Control and Authorization

3.1.1 Background

Establishing regulatory framework and regulatory body

The IAEA international safety standards outline the responsibilities and functions of the government. GSR Part 1 (Rev. 1) [14], establishes requirements on: the essential aspects of the governmental and legal framework; establishing a regulatory body; and taking actions necessary to ensure the effective regulatory control of facilities and activities — existing and new — utilized for peaceful purposes.

Paragraph 2.2 of GSR Part 1 (Rev. 1) [14] states:

“The government establishes national policy for safety by means of different instruments, statutes and laws. Typically, the regulatory body, as designated by the government, is charged with the implementation of policies by means of a regulatory programme and a strategy set forth in its regulations or in national standards. The government determines the specific functions of the regulatory body and the allocation of responsibilities. For example, the government establishes laws and adopts policies pertaining to safety, whereas the regulatory body develops strategies and promulgates regulations in implementation of such laws and policies. In addition, the government establishes laws and adopts policies specifying the responsibilities and functions of different governmental entities in respect of safety and emergency preparedness and response, whereas the regulatory body establishes a system to provide effective coordination.”

GSR Part 1 (Rev. 1) [14] also includes specific requirements for the regulatory body, within the broader government infrastructure. Paragraph 4.2 of GSR Part 1 (Rev. 1) [14] states that: “The responsibilities of the regulatory body shall be discharged within, and are dependent upon, the governmental and legal

framework for safety.” While the regulatory body operates within the overall governmental and legal framework for safety, the importance of the independent role of the regulatory body is emphasized in Requirements 3, 4 and 17 of GSR Part 1 (Rev. 1) [14]. For example, Requirement 4 of GSR Part 1 (Rev. 1) [14] states that: “The government shall ensure that the regulatory body is effectively independent in its safety related decision making and that it has functional separation from entities having responsibilities or interests that could unduly influence its decision making.”

Authorization of discharges from a facility or activity

For facilities or activities that might present potentially higher radiation risks, it may be appropriate for the regulation of discharges from such facilities or activities to be managed by means of an authorization (registration or licensing, as relevant) that establishes stringent technical and regulatory conditions, including for the adequate management and control of these discharges and their radiological consequences.

GSR Part 3 [8] establishes requirements and GSG-9 [9] provides recommendations on the regulatory control and authorization of discharges for both the regulatory body and the licensee or applicant.

Paragraph 5.2 of GSG-9 [9] states that “the regulatory body should establish the authorization process for facilities and activities, including provisions for discharges, using the concept of a graded approach, in accordance with the expected radiological impact on the public and the environment.”

Paragraph 5.31 of GSG-9 [9] states:

“The regulatory body should establish the process to be followed by an applicant seeking an authorization for discharges once the need for an authorization for discharges has been established. The steps of the authorization process may be as follows:

- a) The regulatory body should specify the relevant dose constraint for the facility or activity under consideration (see paras 5.15–5.19 and the Annex).
- b) The applicant should characterize the discharges and the main exposure pathways identified, in order to assess adequately the exposure of the representative person.
- c) The applicant should present the measures to be used for the optimization of protection and safety of the public, having given consideration to measures for keeping the exposures due to discharges as low as reasonably achievable and having taken into account all relevant factors.
- d) The applicant should assess the doses to the representative person. This may involve a number of iterations, starting with a simple, cautious generic assessment and, if necessary, a more detailed, site specific study.
- e) The applicant should submit the results of the assessment to the regulatory body. The regulatory body should evaluate whether the models and assumptions used by the applicant are appropriate, should compare the results of the assessment with dose limits and dose constraints, and should evaluate whether the assessed doses are in accordance with the need to provide optimized protection of the public.
- f) The regulatory body should set the discharge limits and should establish conditions by which compliance during operation is to be demonstrated, including by means of source monitoring and environmental monitoring systems and programmes.
- g) The regulatory body should issue an authorization for discharges upon its satisfaction that the models and assumptions are valid and that the doses will not be higher than the optimized levels.”

These steps are summarised in a figure within GSG-9 [9], which is copied below (see Figure 3.1.). Figure 3.1. also shows those responsible for each step of the process.

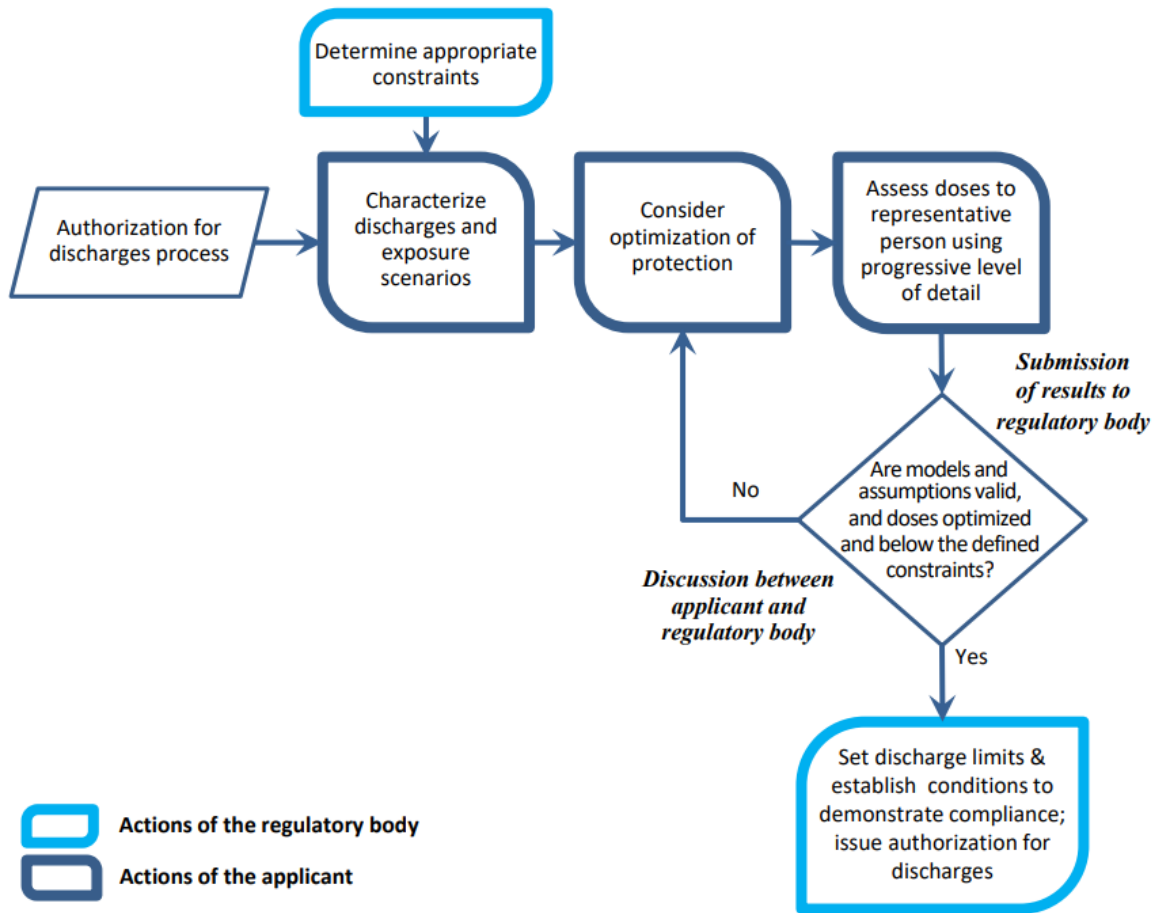

Figure. 3.1: Steps in setting discharge limits, indicating those responsible (FIG. 3 of GSG-9 [9])

Establishing dose constraints

Having concluded that there is a need for an authorization, the first step of the authorization process described in GSG-9 [9] (and shown in Figure 3.1) reflects the requirement set out in Paragraph 3.120 of GSR Part 3 [8] that “The government or the regulatory body shall establish or approve constraints on dose and constraints on risk to be used in the optimization of protection and safety for members of the public”.

Once an appropriate dose constraint has been determined by the regulator, the applicant should characterize the discharges and the main exposure scenarios, consider optimisation of protection and assess doses to the representative person, as shown in Figure 3.1. These actions of the applicant are described in more detail in Part 3 (Section 3.4), the output of which is a radiological environmental impact assessment (REIA). This is an iterative process that considers optimization of protection and safety.

Establishing requirement for optimisation of protection

For situations in which individuals are or could be subject to public exposure, Requirement 11 of GSR Part 3 [8] states that “The government or the regulatory body shall establish and enforce requirements for the optimization of protection and safety, and registrants and licensees shall ensure that protection and safety is optimized.” Dose constraints are the starting point for optimization of protection and safety, the intended outcome of which being that all exposures are controlled to levels that are as low as reasonably achievable (ALARA), economic, societal and environmental factors being taken into account.

GSG-8, paragraph 3.33 [10] states that “Optimization of protection and safety can be applied to the component parts of a particular practice and can be limited to consideration of the doses to particular groups of people. However, the boundary conditions for any analysis for the purposes of optimization should be carefully chosen since there may be consequences for other component parts of the practice or other groups of people. For instance, the costs and benefits of different effluent treatment options at a nuclear power plant should be considered in the optimization of protection of the public and protection of the environment against exposures due to radioactive discharges to the environment. Some of these options may have significant implications for the way solid wastes are stored at the facility, or for the occupational exposure of workers, which also have to be considered in the optimization process.”

Paragraph 5.32 of GSG-9 [9] states that “When the projected doses to members of the public are of the order of 10 μ Sv per year or below, a process for optimization should not normally be required, on the basis that the efforts for further dose reduction would generally not fulfil the requirement for optimization.”

Establishing discharge limits

The final step prior to issuing an authorization involves the regulatory body establishing discharge limits for facilities and activities to control the exposures to the public and ensure that protection of members of the public is optimized from the radiation protection perspective. As stated in Paragraph 5.43 of GSG-9 [9], “To set the discharge limits, prospective estimates of the dose to members of the public should be used to determine acceptable optimized discharge levels that meet the established radiological criteria” (the dose constraint).

The discharge limits are usually set as Bq per year of each radionuclide discharged. If the discharge limit is expressed as an activity concentration, the associated volume needs to be specified.

Paragraph 3.123 of GSR Part 3 [8] requires that “The regulatory body shall establish or approve operational limits and conditions relating to public exposure, including authorized limits for discharges. These operational limits and conditions:

- a) Shall be used by registrants and licensees as the criteria for demonstration of compliance after the commencement of operation of a source;
- b) Shall correspond to doses below the dose limits with account taken of the results of optimization of protection and safety;
- c) Shall reflect good practice in the operation of similar facilities or activities;
- d) Shall allow for operational flexibility;
- e) Shall take into account the results of the prospective assessment for radiological environmental impacts that is undertaken in accordance with requirements of the regulatory body.”

The submission of the REIA to the regulatory body, discussion of the results and review by the regulatory body is an iterative process and is described in further detail in Part 3 (Section 3.4).

By setting the discharge limits and conditions under which the practice is authorized, the environment is assumed to be protected from the effects of ionizing radiation. Some Member States consider that, in addition to the optimization of the protection of the public, it may be necessary to assess protection of the environment explicitly, including, for instance, estimation of the impact of radiation exposure on populations of flora and fauna. This is described in more detail in Part 3 (Section 3.4).

Issuance, inspection and enforcement of authorization

The regulatory body is responsible for issuing an authorization for discharges. As stated in Paragraph 5.59 of GSG-9 [9] “The authorization for discharges should take the form of written permission from the regulatory body.” The authorization includes specific operational limits and conditions placed on the discharges.

Paragraph 5.60 of GSG-9 [9] goes on to say that “The regulatory body should record formally the basis for its decision on an authorization for discharges, or on the amendment, renewal, suspension or revocation of the authorization for discharges, and should inform the applicant, in a timely manner, of its decision, including the reasons and justification.”

Requirement 31 of GSR Part 3 [8] on radioactive waste and discharges states that “Relevant parties shall ensure that radioactive waste and discharges of radioactive material to the environment are managed in accordance with the authorization.” Therefore, once the regulatory body has formally authorized the discharge, the discharge can commence according to the operational limits and conditions (including discharge limits) set out in the authorization. The regulatory body should then review performance against the authorization. Paragraph 5.92 of GSG-9 [9] specifically requires that “The regulatory body should verify compliance with the regulatory requirements and the operational limits and conditions of the authorization for discharges.” Paragraph 5.93 goes on to state that “The regulatory body should establish a process for identifying and managing any identified non-compliance with the regulatory requirements on discharges.”

Process for reviewing authorization

The international safety standards require that the regulatory body performs a periodic review of the existing authorization. Paragraph 5.10 of GSG-9 [9] states that “The authorization for discharges should be reviewed during the operation stage, for example as part of a periodic safety review of the facility or activity. Significant changes in any condition that could affect public exposure should be taken into account during the review of an existing authorization.”

3.1.2 Review and Assessment

Establishing regulatory framework and regulatory body

Over the two missions focused on the NRA (see Annex 1), the NRA described: the establishment of the NRA as the regulatory body, after the accident at FDNPS; the responsibilities and functions of the NRA; and the coordination of different Japanese authorities for the ALPS treated water discharge. The NRA went on to provide an overview of the legal structure for safety, which includes the Atomic Energy Basic Act, the Reactor Regulation Act, cabinet orders, NRA ordinances, regulatory guides and technical documents, when appropriate. The NRA also highlighted the unique legal and regulatory framework that pertains to FDNPS and its status as a ‘Specified Nuclear Facility’ under the Reactor Regulation Act. Annex 4 has further information on the relevant legal and regulatory provisions applied to the FDNPS.

The NRA provided an overview of how the ALPS treated water discharge is coordinated across the Government of Japan and with different competent authorities and agencies from a legal, policy making and technical perspective. The NRA noted that decision-making for handling ALPS treated water issues is coordinated through the Inter-Ministerial Council for Contaminated Water, Treated Water and

Decommissioning Issues. This council includes representatives from different ministries including Ministry of Economy, Trade and Industry (METI), Ministry of Agriculture, Forestry and Fisheries (MAFF), and Ministry of Environment (MOE), Ministry of Education, Culture, Sports, Science and Technology (MEXT). The NRA Chairman attends to provide technical and scientific advice to the council, but not to participate in decision making. The NRA further described the role of the council as the entity that facilitated the decision on the Basic Policy and how it will be implemented.

Over the two missions, the Task Force developed a clear understanding of the approach followed by the Government of Japan with regard to the proposed ALPS discharge. The Task Force was able to confirm that the NRA serves as the independent regulatory body within Japan, has promulgated and implemented an appropriate legal and regulatory framework for safety, and holds the responsibility for assessing the safety of the proposed discharge of ALPS treated water.

Process for authorization

In the first mission to NRA, NRA explained that the discharge of ALPS treated water is a controlled discharge and therefore NRA considers the activity to be a planned exposure situation that requires authorization. However, NRA went on to explain that the discharges cannot be managed using their traditional regulatory approach because FDNPS presents a unique situation. The NRA provided as an example the fact that even though there are no existing explicit requirements or guidance for the applicant to conduct an REIA, the NRA decided to review the REIA conducted by TEPCO to ensure that TEPCO's plan is in line with the Basic Policy. As a consequence of this less-prescriptive approach, the process for authorization was a key topic of discussion during the second mission at which point the domestic regulatory process had progressed significantly.

During further discussions with NRA, it became apparent that the *Implementation Plan for Fukushima Daiichi Nuclear Power Station Specified Nuclear Facility*, prepared by TEPCO, is a core document within the authorization process. This document is broadly referred to as the "Implementation Plan" within this report. In response to the Basic Policy, TEPCO has submitted numerous "Application Documents for Approval to Amend the Implementation Plan for Fukushima Daiichi Nuclear Power Station Specified Nuclear Facility" to include details of the design and operation of facilities for the discharge of ALPS treated water, and an associated radiological environmental impact assessment of discharging the ALPS-treated water into the sea. NRA's review of this amended Implementation Plan is core to the authorization process. See Annex 3 for a list of the revisions to the Implementation Plan submitted during the IAEA's safety review.

NRA summarised the process for approving the Implementation Plan and authorizing the discharge of ALPS treated water, as follows:

1. Requirements are listed in Reactor Regulation Act and the Basic Policy for discharge of ALPS treated water.
2. TEPCO writes the Implementation Plan (or revisions thereto) to reflect all relevant regulatory and legal requirements and submits the Implementation Plan to NRA for review.
3. NRA reviews the Implementation Plan and documents its findings in the "Review Results Document".
4. Once the revised Implementation Plan is approved by NRA (i.e., NRA confirms that the Implementation Plan meets all relevant regulatory and legal requirements) then the Implementation Plan becomes the legally binding document that describes the operational limits and conditions.
5. NRA performs inspections as part of its routine regulatory oversight to ensure that TEPCO complies with all aspects of the approved Implementation Plan.

As part of the authorization process, review meetings are held between TEPCO and NRA to discuss and iterate the Implementation Plan. These review meetings are open to the public. Furthermore, prior to approval, NRA publishes the draft Review Results Document for 30 days of public review and comment. The NRA considers submitted comments to determine whether changes are required. Following any changes, the NRA Commission approves the final Review Results Document and the proposed revisions to the Implementation Plan are officially accepted.

For the ALPS treated water discharges, given that new facilities are being constructed, the authorization process concludes only following final pre-service inspections to confirm that the relevant equipment and facilities are installed and ready to be operated in accordance with the approved Implantation Plan.

Establishing dose constraints

After discussions between the Task Force and METI/TEPCO during the first mission, the Task Force noted that the concept of a dose constraint does not exist in Japanese law. Following discussions with the Task Force, NRA confirmed that the criterion of 0.05 mSv per year established by NRA for the discharge of ALPS treated water – which is the operational target for nuclear power stations in Japan – could be interpreted as a dose constraint. Paragraph 5.16 of GSG-9 [9] states that “in practical terms, dose constraints should be selected within the range of 0.1 to less than 1 mSv in a year”. With this in mind, the Task Force noted that the selected dose constraint of 0.05 mSv per year is below this range and is therefore conservative.

During the first mission to NRA, NRA explained that in addition to the criterion established by NRA for the ALPS treated water discharges (0.05 mSv per year), NRA uses a second dose criterion from the Reactor Regulation Act (1 mSv per year from a hypothetical extreme situation at the site boundary). The Task Force noted that the differences between these two criteria are difficult for interested parties to understand and that it should be clearly explained when establishing the dose constraint for the ALPS treated water discharge.

During the second mission, the NRA further explained to the Task Force the difference between the two dose criteria. The dose criterion from the Reactor Regulation Act is for the whole FDNPS site, which is managed as an existing exposure situation. Consequently, NRA requires that the additional effective dose resulting from a hypothetical extreme situation at the site boundary is less than 1 mSv per year. NRA indicated that very conservative assumptions are made in assessing the dose from all the exposure pathways considered for comparison with the 1 mSv per year dose criterion at the site boundary. The dose criterion for ALPS treated water discharge is a dose constraint of 0.05 mSv per year from ALPS treated water discharge to the representative person using habit data typical of the population living in the region. In summary, NRA explained that the discharge of ALPS treated water is a controlled discharge and therefore NRA considers the activity to be a planned exposure situation. However, this is occurring within the context of the larger FDNPS site, which is managed as an existing exposure situation. Therefore, two dose criteria are being used by NRA.

The Task Force understands why these two criteria are used by NRA and noted that the use of the two dose criteria is not an issue of consistency with the international safety standards. However, the Task Force believes that having two dose criteria, apparently both relating to the discharge of ALPS treated water but calculated in very different ways, could be a source of confusion for interested parties. Therefore, the Task Force viewed it as important for NRA to devote effort towards explaining this difference to the public to avoid unnecessary confusion.

The Task Force acknowledged the importance of the consideration of the whole FDNPS. To avoid confusion, the Task Force advised that the whole site should be taken account of when optimising protection for the discharge of ALPS treated water.

Establishing requirement for optimisation of protection

Optimization of protection is fundamental to the authorization of discharges (SF-1, GSR Part 3 and GSG-9) and has therefore been a significant component of IAEA's review.

The Task Force confirmed that it is interested only in optimization of protection associated with discharges of ALPS treated water.

During the first mission to NRA, the Task Force highlighted how dose constraints are used by the operator as a boundary condition when defining the range of options for the purposes of optimization of protection and safety of members of the public, and that this in turn informs the setting of discharge limits by the regulatory body (see Figure 3.1.).

During the second mission to NRA, the NRA provided the Task Force with descriptions of where it specifies the requirement for optimization of protection. Firstly, the NRA highlighted the text from the "Specific Regulatory Requirements" that describes the requirement for optimization of protection from the overall site against the reference level of 1 mSv per year. The NRA also stated that the dose constraint of 0.05 mSv per year was set for discharges of ALPS treated water "with the recognition that optimization of protection is to be considered in the range below the dose constraint". Subsequently, the NRA confirmed it will continue to evaluate whether ALPS treated water discharges contribute to the progress of decommissioning. When revising 'Measures for Mid-term Risk Reduction for decommissioning TEPCO's Fukushima Daiichi NPS', NRA will require an explanation from TEPCO regarding optimization of protection based on their operational experience of the discharges. The Task Force acknowledged these references to optimization.

Establishing discharge limits for tritium

During the first NRA mission, the Task Force noted that the discharge limit for tritium is pre-defined in the Government Policy for discharges of ALPS treated water as 22 TBq per year, which is equivalent to the pre-accident discharge limits at FDNPS. The Task Force recognized that the value of 22 TBq per year is fixed and noted that the value has been chosen without reference to the dose to the representative person calculated in the REIA and the optimization of protection and safety. However, the Task Force understands that discharge limits set in government policy were influenced by a wide range of prevailing circumstances, such as societal concerns and a desire to reduce radioactivity being released to the environment, and that these factors dominated the optimization process. The Task Force is content that this is consistent with the requirement for optimization of protection in the IAEA international safety standards.

The Task Force noted that the doses predicted in the REIA are significantly below (more than 1,000 times lower than) the dose constraint. Therefore, the Task Force emphasised the importance of requiring optimisation of protection in the future to inform the NRA's review of discharge limits, noting that that optimization is not the same as dose minimization. Furthermore, the Task Force noted that it is helpful to show interested parties that a higher discharge rate would still meet the dose constraint and that the discharge limit defined in government policy is already sufficiently conservative to take account of societal concern.

The NRA informed the task Force that TEPCO plans to periodically revisit the annual amount of tritium to be discharged taking into account factors to be considered in the optimization process. The NRA also stated that if discharges of ALPS treated water hampers the progress with decommissioning, it might require TEPCO to reconsider the discharge amount below the range of the dose constraint.

The Task Force emphasized to NRA that revising the discharge limit for tritium will have implications for discharge limits for other radionuclides as well as other operational limits and conditions.

Establishing discharge limits for other radionuclides

The NRA explained that it does not intend to set discharge limits for other radionuclides because tritium is the only radionuclide that cannot be removed by ALPS treatment to meet existing regulatory concentration limits for the discharge of radioactive effluents into the environment (regulatory concentration limits are established in the “Notification Establishing Dose Limits, etc. Based on the Provisions of the Regulations, etc. Concerning the Refining Business of Nuclear Source Material or Nuclear Fuel Material”). All other radionuclides are subject to operational conditions based on these regulatory concentration limits along with a requirement that the sum of ratios (i.e., the sum of each radionuclide concentration in the discharge divided by the regulatory concentration limits) needs to be less than one. Contaminated water is treated by ALPS until these regulatory concentration limits are met. The discharge limit for tritium in Bq per year and the regulatory concentration limits for other radionuclides in Bq per litre work together to control the quantity of other radionuclides discharged.

The Task Force understands the logic for not setting discharge limits for radionuclides other than tritium. However, the Task Force also noted that additional discharge limits may be required, if the discharge limit for tritium is changed in the future as a result of optimisation of protection by TEPCO.

The NRA agreed with the Task Force’s observations in this regard and the Task Force has noted that this topic will be part of the on-going review by the IAEA in the future.

Separately, the Task Force noted that the regulatory concentration limits are based on a very conservative scenario that is unrelated to the exposure pathways for the discharges of ALPS treated water; the concentration limits are based on a dose limit of 1 mSv per year to a hypothetical person at the site boundary who is drinking 2 litres of water per day rather than a dose constraint of 0.05 mSv per year to a representative person. The Task Force noted that applying these conservative concentration limits to discharges is resulting in the need for dilution of the ALPS treated water prior to discharge, and that care should be taken not to imply that dilution is performed for the purposes of radiation protection and safety (the REIA considers the amount of radioactivity released into the environment in a year rather than the concentration at which it is discharged). The Task Force acknowledged that Japan might choose to dilute discharges for other reasons (e.g., to keep local radionuclide concentrations low at the point of discharge, or to manage reputational risks) and advised that the reasons for dilution should be clearly stated.

Issue, inspection and enforcement of authorization

The NRA does not issue an authorization as such, rather the NRA reviews the Implementation Plan and documents its findings in the “Review Results Document”. Once the revised Implementation Plan is approved by NRA then the Implementation Plan becomes the legally binding document that describes the operational limits and conditions for the discharge. NRA then performs inspections as part of its routine regulatory oversight processes to ensure that TEPCO complies with the approved Implementation Plan. The Task Force understands that NRA is utilising multiple processes to verify TEPCO’s compliance with the approved Implementation Plan with a focus on inspection and independent monitoring annually (see Section 3.2).

The Task Force observed that limits and conditions in the Implementation Plan are mainly focussed on the hardware (e.g., equipment, etc.) and actions to be taken if these are not met. However, NRA also highlighted the ‘softer’ conditions (e.g., conditions associated with management systems, competency, quality management, etc.) that are part of the Implementation Plan and within the Quality Management System in place.

NRA noted that the Reactor Regulation Act states that if operational safety measures performed by TEPCO are not in compliance with the Implementation Plan, “NRA may order TEPCO to take measures necessary

for operational safety, including suspension of discharge or alteration of the design on the Discharge Facility”.

NRA explained that the Implementation Plan describes TEPCO’s response to “unusual occurrences”, “unusual values” and “significant discrepancies”. However, the Task Force noted that some of the action limits for a response or the acceptable tolerances that will be implemented are still to be defined. The Task Force acknowledged that it is not yet possible to define some of the action limits that are related to environmental monitoring because the variation in reported monitoring results have not yet been fully established. Subsequently, the NRA explained that necessary action limits for a response or the acceptable tolerances that will be implemented would be defined in TEPCO’s internal documents before the start of discharges.

Process for reviewing authorization

The NRA explained the process of periodic review to the Task Force. TEPCO is required to update the Implementation Plan whenever changes are proposed (including any changes to the source term, REIA, monitoring programmes, etc.), and that the NRA will then review the revised plan against the requirements in the Reactor Regulation Act and Government Policy for discharge of ALPS treated water. Once the revised Implementation Plan is approved by the NRA it will become legally binding.

The NRA stated that periodic review of the authorization of discharge will be conducted within the process of optimization of protection related to the decommissioning activities for the whole site, typically once per year.

The Task Force discussed with the NRA the importance of deciding the appropriate period for the validity of the authorization that will be issued, and of selecting criteria for future review of the discharge limits or setting a time interval for conducting periodic review of the discharge limits. The NRA described the process for reviewing the authorization in the future and informed the IAEA that this will be conducted within the process of optimization of protection related to the decommissioning activities for the whole site, typically once per year.

3.1.3 Conclusions

The IAEA has concluded that the approach taken by TEPCO and NRA is consistent with the relevant international safety standards included under this section of the report. Further detailed findings are included below:

- NRA serves as the independent regulatory body within Japan, has promulgated and implemented an appropriate legal and regulatory framework for safety, and holds the responsibility for assessing the safety of the proposed discharge of ALPS treated water.
- An authorisation process has been established, the core of which is NRA’s approval of the “Application Documents for Approval to Amend the Implementation Plan for Fukushima Daiichi Nuclear Power Station Specified Nuclear Facility” submitted by TEPCO. During the authorization process, both parties play a role in ensuring compliance with requirements listed in Reactor Regulation Act and Basic Policy. It is an iterative process that includes a period of public review and comment on NRA’s “Review Results Document”.
- NRA confirmed that the ‘dose target’ of 0.05 mSv per year established by NRA for the discharge of ALPS treated water could be interpreted as a dose constraint. The selected dose constraint of 0.05 mSv per year is below the range from which the dose constraint should be selected according to Paragraph 6.16 of GSG-9 [9].

- NRA highlighted a requirement in the “Specific Regulatory Requirements” that describes the need for optimization of protection from the overall site and stated that NRA will require an explanation from TEPCO regarding optimization of protection based on their operational experience of discharge when revising ‘Measures for Mid-term Risk Reduction for decommissioning TEPCO’s Fukushima Daiichi NPS’.
- The discharge limit for tritium is pre-defined in the Government Policy for discharges of ALPS treated water as 22 TBq per year, which is equivalent to the pre-accident discharge limits at FDNPS. The Task Force notes that the discharge limit was selected without reference to the dose to the representative person calculated in the REIA and the optimization of protection and safety. However, the Task Force understands that discharge limits set in government policy were influenced by a wide range of prevailing circumstances, and that these factors dominated the optimization process. The Task Force is content that this is consistent with the requirement for optimization of protection in the IAEA safety standards.
- The Task Force encouraged the NRA to set discharge limits based on the REIA in the future after additional operational experience and sampling data has been collected; it would be helpful to set discharge limits for radionuclides that, according to the REIA, contribute most to the dose to the representative person, even though the overall dose from these radionuclides and tritium is very low. This could be considered in the future if the discharge limit for tritium is changed as a consequence of optimization of protection by TEPCO.
- The use of conservative concentration limits results in the need for dilution of the ALPS treated water before discharge. The Task Force notes that care should be taken not to imply that dilution is performed for the purposes of radiation protection and safety.
- A process exists for reviewing the authorization of discharges, which will occur whenever TEPCO updates the Implementation Plan and also within the process of optimization of protection related to the decommissioning activities for the whole site, typically once per year.

3.2. Safety Related Aspects of Systems and Processes for Controlling Discharges

3.2.1 Background

Requirement 13 of GSR Part 3 [8] states that: “The regulatory body shall establish and enforce requirements for safety assessment, and the person or organization responsible for a facility or activity that gives rise to radiation risks shall conduct an appropriate safety assessment of this facility or activity.”

In accordance with the requirements established in GSR Part 3 [8], the licensee is required to conduct an appropriate safety assessment for the discharge of ALPS treated water from the Fukushima Daiichi nuclear power station and submit it for subsequent review and assessment by the regulatory body prior to authorization.

The safety assessment aims to identify the ways in which exposures could be incurred, to determine the

expected likelihood and magnitudes of exposures in normal operation and to assess the adequacy of the provisions for protection and safety.

The safety assessment is required to include a review of the operational limits and conditions for the operation of the discharge; the ways in which structures, systems and components relating to protection and safety might fail, and the consequences of such events; the ways in which external factors could affect protection and safety; the ways in which operating procedures relating to protection and safety might be erroneous, and the consequences of such errors.

3.2.2 IAEA Review and Assessment

During its review, the Task Force considered the safety assessment included in the revised Implementation Plan, and other associated operational documents created by TEPCO in preparation for the beginning of discharges. The revised Implementation Plan, approved by NRA on 22 July 2022 and 10 May 2023, includes a number of technical descriptions of the facilities, equipment, and processes to be used as part of the planned discharges of ALPS treated water. This information is summarized below, however further details can be found in the publicly available version of the revised Implementation Plan.

The facilities and equipment installed by TEPCO to facilitate and manage the discharge of ALPS treated water are comprised of four main components: the Measurement and Confirmation Facility, the Transfer Facility, the Dilution Facility, and the Discharge Facility. Further details on each other components are included below.

Measurement/Confirmation Facility

This facility is composed by 35 tanks each with a size of approximately 1,000m³, located in the K4 tank area. There are 3 groups of 10 tanks plus an additional 5 tanks for storage. The three tank groups (10 tanks each) fulfil one of three functions at any given time: receiving, measurement and confirmation, and discharge. The tank groups fulfil these roles in a rotating basis as highlighted below in Figure 3.2. The tank group responsible for receiving will be empty initially and will be filled with water from tanks elsewhere on the FDNPS site either directly, or after undergoing secondary treatment by ALPS. The tank group responsible for measurement and confirmation will be homogenized using installed agitators and circulation pumps, for approximately one week, before sampling is conducted. The samples taken by TEPCO will be analysed for a wide range of radionuclides and after approximately two months the results will be available. After the analytical results are available, TEPCO will ensure all relevant regulatory discharge limits are met and will calculate the necessary dilution required to keep the overall tritium discharge at 1,500 Bq/L or less. To prevent human error, the tritium concentration confirmed in the process of measurement and confirmation will be mechanically read by a scanner and registered in a monitoring and control device. The monitoring and control device automatically calculates an appropriate flow rate for ALPS treated water from the discharge tank group.

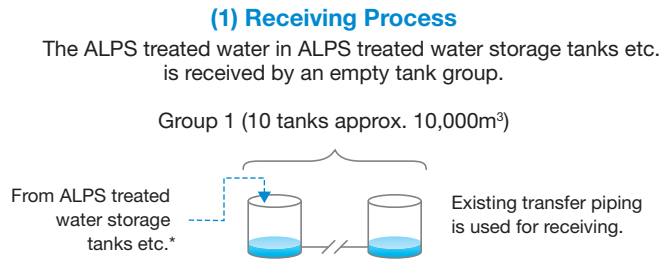

(2) Measurements/confirmation process

After the water quality of the tank group is homogenized by agitating equipment and circulation pump, sampling is carried out to confirm whether the discharge standard is satisfied.

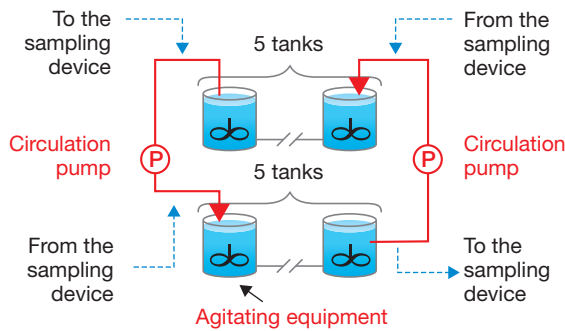

(3) Discharge process

After confirming that the discharge criteria are satisfied, the ALPS treated water is transferred to the dilution facility by the transfer facility.

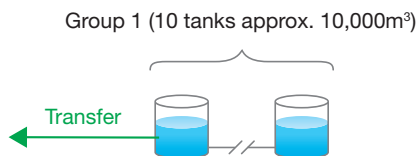

K4 area tank group: 35 tanks

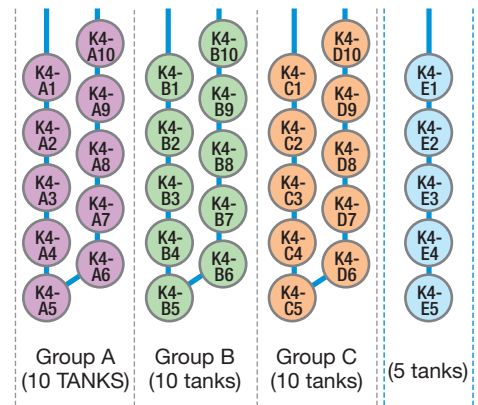

ALPS treated water dilution/discharge facility

Storage tank for ALPS treated water, etc.

	Group A	Group B	Group C
1st cycle	Receiving	-	-
2 st cycle	Measurement/confirmation	Receiving	-
3 st cycle	Discharge	Measurement/confirmation	Receiving
4 st cycle	Receiving	Discharge	Measurement/confirmation
-	Measurement/confirmation	Receiving	Discharge

Figure 3.2. Process for receiving, measuring and discharging ALPS treated water

Transfer Facility

The transfer facility is composed of transfer pumps, piping, valves to control the flow, and flowmeters and radiation detectors. Each pump has a 30m³/hour capacity, and the flow rate is managed based on operational needs (see Figure 3.3). The pumps are installed in the transfer facility building near the measurement/confirmation facility 33.5 m above sea level to transfer ALPS treated water from the tanks of the measurement/confirmation facility 33.5 m above sea level to the dilution facility which is downstream. A radiation detector (sodium iodide scintillation detectors) to detect gamma rays is installed on each transfer line and is designed to provide a qualitative screening prior to the treated water reaching the downstream dilution facility. An alarm value will be set for the detectors that would trigger the emergency isolation of the transfer lines if the value were exceeded.

In the transfer facility, the transfer piping is installed to connect the measurement/confirmation facility 33.5 m above sea level to the piping in the dilution facility 2.5 m above sea level. Along this piping emergency isolation valves are installed to enable TEPCO to immediately stop the transfer of treated water should an abnormality be detected. One emergency isolation valve is installed just before the ALPS treated water from the transfer facility reaches the seawater header. The other emergency isolation valve is installed in the ALPS electrical equipment room set up inside the seawall 11.5m above sea level in preparation for the possibility that the other emergency isolation valve does not work (e.g., due to inundation during a

(tsunami). In the same electrical equipment room, flowmeters and additional valves are installed to allow for further operational control of the discharge rate.

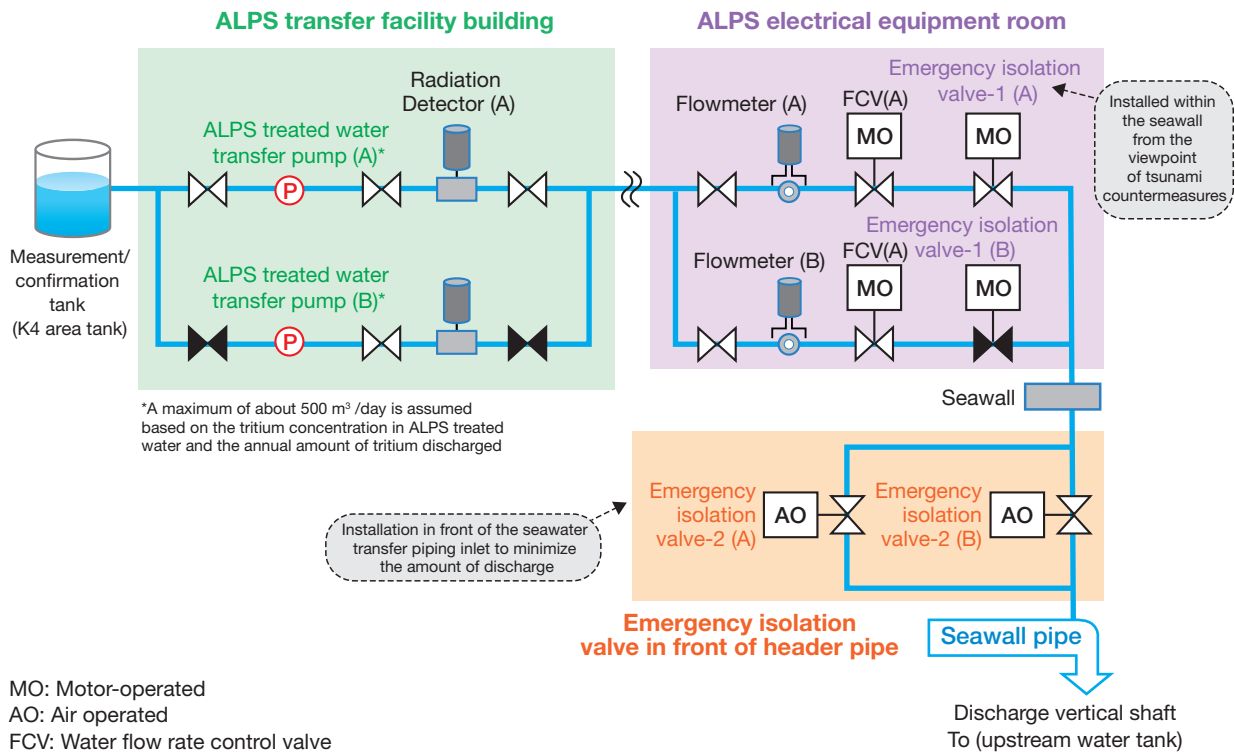

Figure 3.3. Transfer Facility

Dilution Facility

This dilution facility consists of three seawater transfer pumps, piping for each seawater pump to move the seawater to a single large seawater header, and a discharge shaft (upstream water tank) (see Figure 3.4). The overall purpose of this part of the process is to ensure the ALPS treated water is diluted with seawater prior to reaching to discharge facility. Dilution is done by injecting ALPS treated water into the seawater pipe header and allowing it to undergo turbulent mixing. The dilution facility is installed in a location 2.5 m above sea level in the seaside of FDNPS Units 5 and 6.

A flowmeter is installed on each of the three seawater transfer lines to ensure precise control over the dilution factor that is calculated by TEPCO for each batch of ALPS treated water to be discharged. For the seawater transfer pumps, the intake channel for the existing Unit 5 circulation water pump is reused. Conservatively, three pumps (one pump out of three is for spare) are installed.

Because dilution is performed by injecting ALPS treated water into the seawater pipe header, TEPCO analysed the behaviour of the water in the seawater header and downstream piping. TEPCO calculated the expected dilution effect and concluded that the water is diluted more than 350 times by the time it leaves the seawater header.

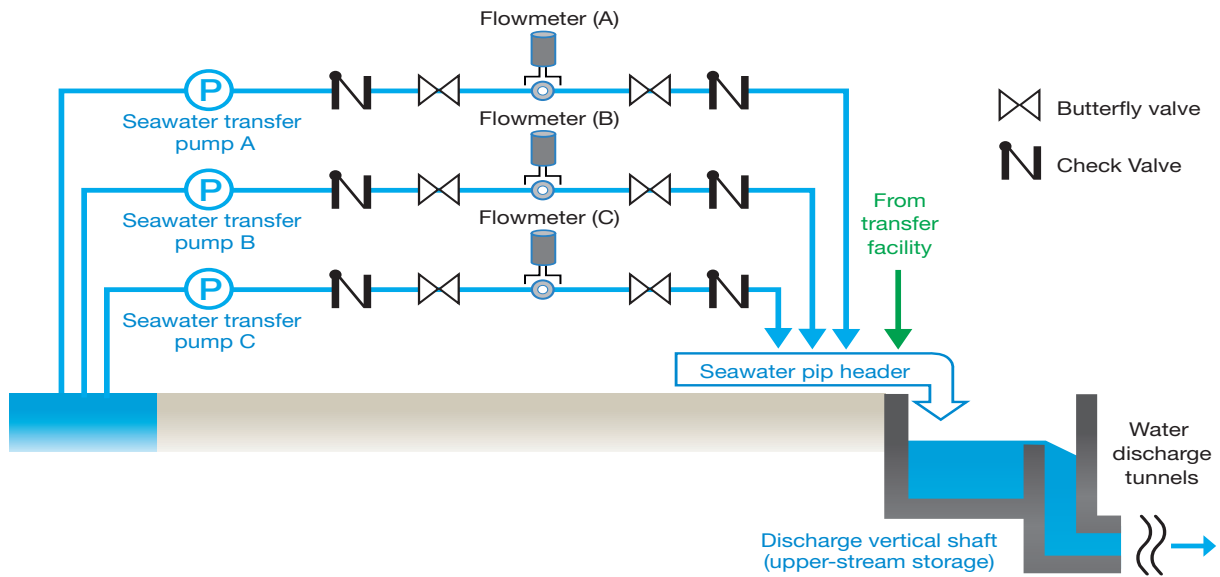
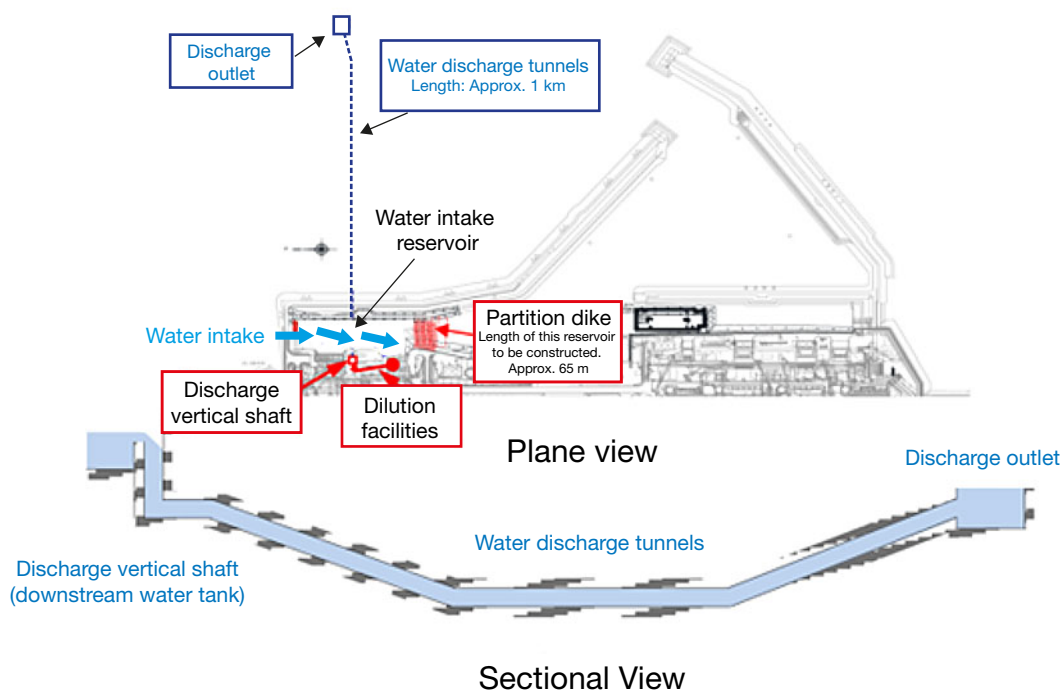

Figure 3.4. Dilution Facility

Discharge Facility

The discharge of treated water occurs through a tunnel running under the seabed about one kilometre off the coast of FDNPS. The discharge facility consists of the discharge vertical shaft, discharge tunnel, and discharge outlet, and is designed to transfer water flowing out over the partition wall (weir which separates the upper-stream storage from the down-stream storage) in the discharge vertical shaft to the outlet, by making use of the difference in height between water in the discharge vertical shaft (down-stream storage) and the sea surface. The discharge tunnel passes through stable bedrock to minimize the risk of leakage and improve seismic resistance. Additionally, the discharge outlet is set within an area where commercial fishing is not conducted on a regular basis.



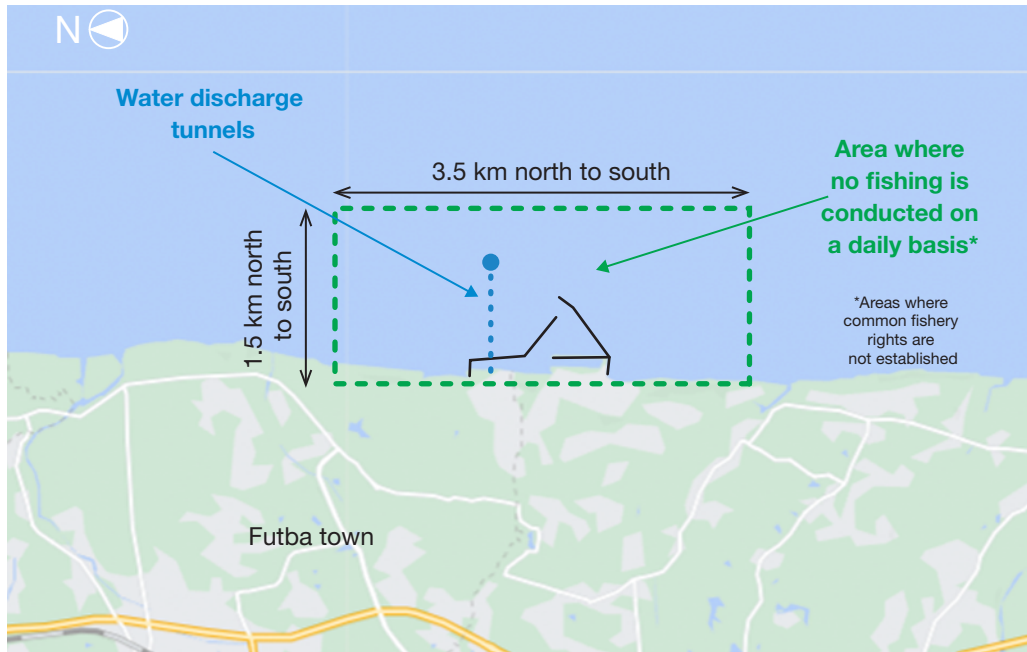

Figure 3.5. a) and b). Position of discharge tunnel for ALPS treated water

Safety Assessment

In order to assess the consistency of the approach with the relevant international safety standards, the Task Force reviewed the systems and equipment that were included in the design for the ALPS facilities noted above. The Implementation Plan, which is approved by NRA, includes the various technical specifications of the equipment and processes in place for the ALPS discharges (e.g., Section II.2.50.2.1 of the Implementation Plan). The Implementation Plan serves as a regulatory authorization for TEPCO at FDNPS and therefore when details are included in the plan, and approved by NRA, they must be adhered to by TEPCO.

The Task Force reviewed the information presented in all versions of the Implementation Plan that were provided throughout 2021, 2022, and 2023. In particular, the Task Force observed that TEPCO had included the relevant materials, tolerances, technical specifications, and layouts for all the equipment and structures necessary to operate the ALPS discharge process. As an example, TEPCO has included material requirements that are intended to avoid leakage over time from corrosion and many components and structures are built to avoid damage due to seismic activity. The IAEA notes that the robust design and engineering features built into the ALPS discharge system, including redundant systems are more than adequate given the expected low dose and low risk from the operation of the discharge process.

The Implementation Plan also includes provisions necessary to meet the various operational limits and conditions applicable for the ALPS discharge process. The main operational limits and conditions that apply can be summarized as:

- Limit the overall discharge of tritium to the environment at no more than 22 TBq per year on an annual basis;
- Limit the tritium concentration in discharged water to no more than 1,500 Bq/L;
- Discharged water must meet the national regulatory limits for the concentration of various radionuclides;
- Engineered features (e.g., emergency isolation valves) and operational procedures are in place to ensure that the transfer of ALPS treated water can stop immediately upon detection of any abnormal events.

As noted in Figure 3.6 and Figure 3.7 multiple checks have been included throughout the system to avoid any unintended release of ALPS treated water that does not meet the criteria above. Furthermore, redundant safety features are installed into the system to ensure that failure of a single component will not result in the violation of any operational limits and conditions. However, as would be expected, the safety assessment includes careful consideration of how abnormal occurrences will be identified and addressed. Section III.3.1.9.3 of the Implementation Plan [15] includes significant detail on the operation of the discharge process to ensure the emergency shutdown of the system is possible to ensure any “unintentional discharge of ALPS treated water into the sea” is avoided.

The system includes engineered design features to allow alarms to automatically shut down the ALPS discharge process, as well as procedural features to allow operators to shut down the process should it be deemed necessary. Figure 3.6 and 3.7 highlight the process and design features utilized by TEPCO to ensure an emergency shutdown can be performed when needed. Examples of the alarms or conditions set to allow for an automatic emergency shut down include:

- Failure of flowmeters
- A high flow rate of ALPS treated water or a low flow rate of seawater for dilution
- The unexpected shutdown of pumps
- A high reading on installed radiation monitors (i.e., above the set alarm level)
- Communication abnormalities with the emergency isolation valves

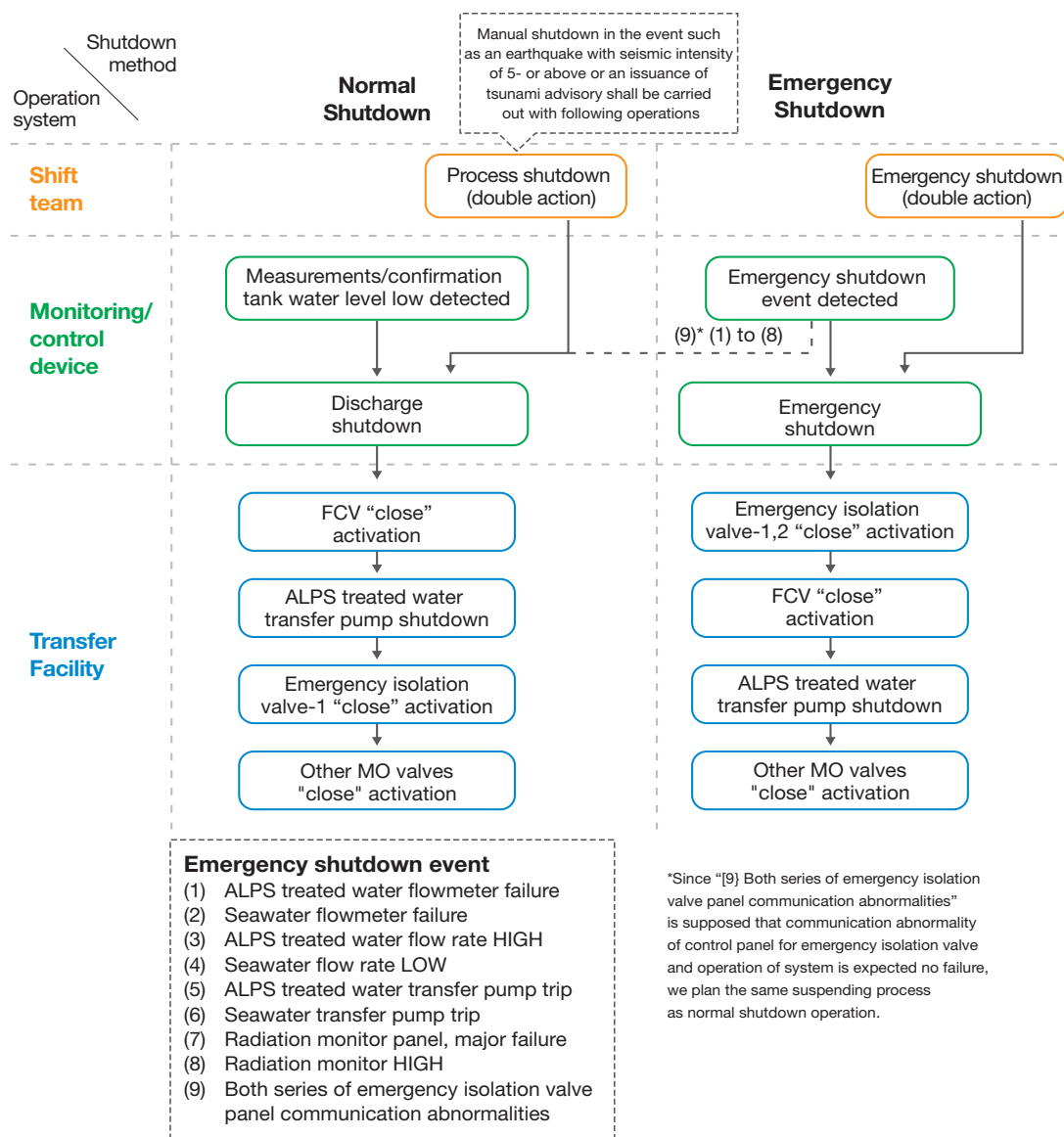

Figure 3.6. Process for normal and emergency shut down of the ALPS discharge

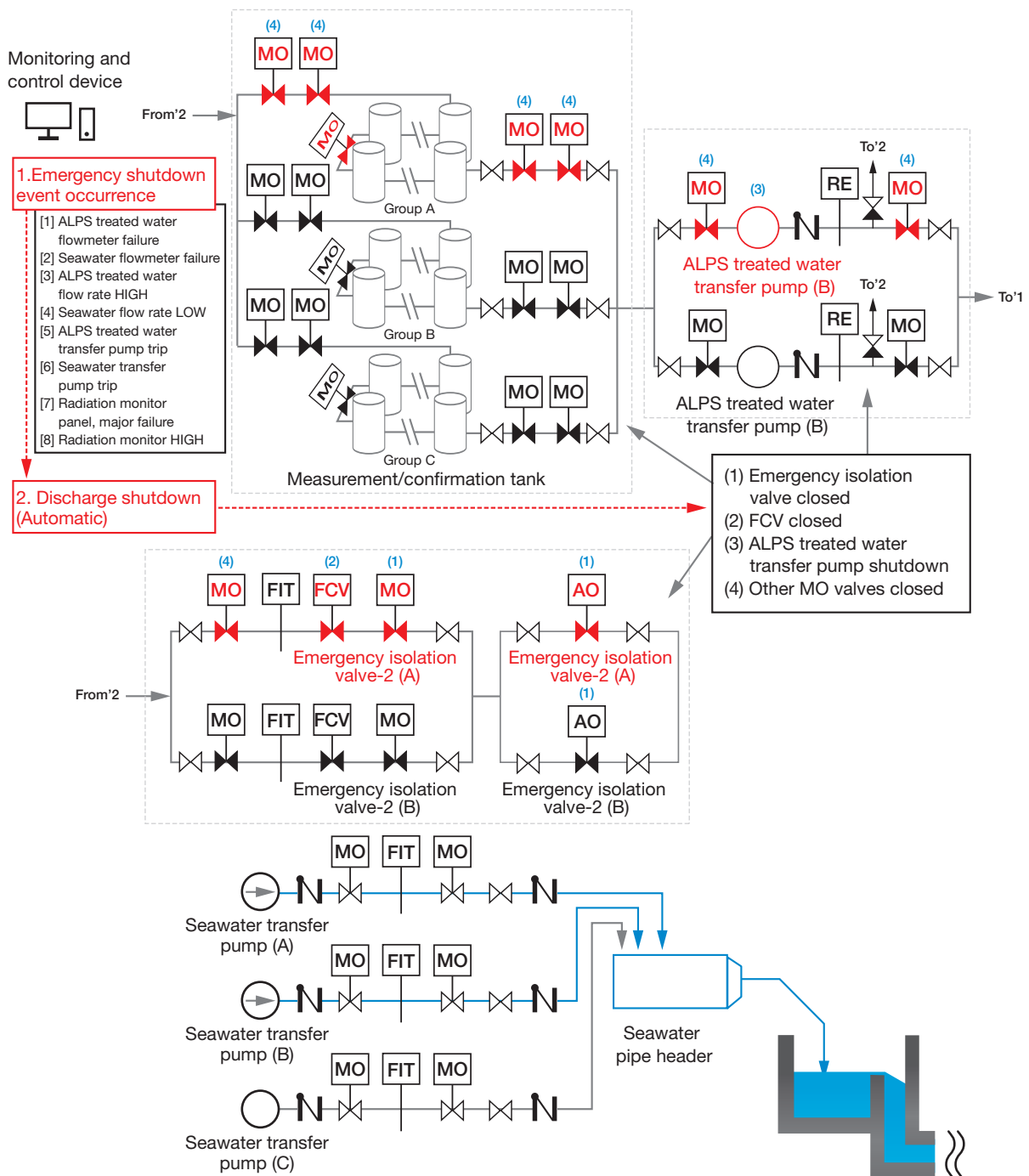

Figure 3.7. Engineered design features for automatic shut down of the ALPS discharge process

The ALPS discharge system is also designed to allow for a manual shutdown based on the operator's consideration of natural phenomena. A series of events have been identified in the Implementation Plan that the operator will consider at all times. For example, an operator will manually shut down the ALPS discharge process in the event a tsunami advisory, hazardous wind watch, or high tide warning are issued. While the system is robustly designed and the risk to the public from an abnormal occurrence is minimal, a conservative approach has been adopted by TEPCO [15] and approved by NRA in this regard.

TEPCO has analysed the process for potential failures and identified three main abnormal events that are used to assess for “initiating events and causes.” Table 3.1 below shows these three abnormal events.

Table 3.1. List of abnormal events from the Implementation Plan.

Abnormal events	
[Definition (1)]	An event of discharging with defective measurements/confirmation of radioactive material (defective measurements/confirmation)
[Definition (2)]	An event of discharging with tritium concentration in the water diluted by seawater being 1,500 Bq/L or more, or with dilution ratio being less than 100 times (insufficient seawater dilution)
[Definition (3)]	An event of discharging without seawater dilution due to leakage out of the system (lack of seawater dilution)

The results of TEPCO’s analysis using a master logic diagram are included in Section III.3.1.9.5.1.3 of the Implementation Plan.

Inspections and Enforcement

As part of its work, the Task Force also considered how the safety assessment would be implemented in a practical manner and what measures are in place to ensure compliance with the details noted above. The Task Force noted that the details of the ALPS discharge facilities are included in the Implementation Plan for TEPCO and that this Implementation Plan serves as the basis for their operations and compliance with regulations. Therefore, during the missions to the NRA the Task Force requested updates on the planned inspection and enforcement programmes for FDNPS that would cover the discharges of ALPS treated water.



Figure 3.8. Pre-service inspection of ALPS discharge facility

NRA provided background information on the inspection and enforcement programmes during both missions focused on the NRA. In the pre-operational phase, the NRA conducts inspections called “pre-service inspections” which serve the purpose of verifying that the installation and performance of all various components and systems that make up the ALPS discharge facilities are ensured prior to the commencement of operations. The NRA highlighted that TEPCO is not authorized to begin discharges until all relevant pre-service inspections have been completed in a satisfactory manner. As part of its work, the Task Force periodically visited FDNPS to witness the conduct of pre-service inspections. (see Figures 3.8 -3.10)



Figure 3.9. Inspection of the construction of the discharge tunnel

In particular, the Task Force witnessed inspections to pressure test the piping in the transfer facility, to verify the operation of leak detection monitors and their alarm annunciation in the control room, and the inspection of the construction of the discharge tunnel prior to it being filled with seawater. These activities were conducted systematically by the NRA, using clearly defined benchmarks for what constitutes acceptable performance; the results of these inspections are posted on the NRA’s public webpage (in Japanese). At the very end of the pre-operational phase, the NRA conducted an inspection of TEPCO’s demonstration of the entire system at once. This final pre-service inspection, which the IAEA was present to observe, demonstrated that all components and systems were installed and functioning as expected.



Figure 3.10. Pre-service inspection of ALPS discharge facility

The NRA also provided an explanation of the operational inspection programme in place at FDNPS and the corresponding enforcement programme in place. At FDNPS, NRA maintains a contingent of about 10 resident inspectors and always have at least one inspector on-site, 24 hours a day. During visits to FDNPS, the Task Force observed that the NRA conducts routine operational inspections consistent with their mandate as an independent safety regulatory body and provided examples of the inspection documentation and enforcement manual to the Task Force for their review.

3.2.3 Conclusions

The IAEA has concluded that the approach and activities undertaken by TEPCO and NRA are consistent with the relevant international safety standards included under this section of the report. Further detailed findings are included below:

- TEPCO has conducted a specific safety assessment for the planned discharges of ALPS treated water at FDNPS that is appropriate for the pre-operational and operational phases.
- TEPCO has incorporated relevant operational conditions and limits in their safety assessment as well as consideration of important concepts such as redundancy for safety related systems and potential failure modes, and the planned maintenance of facilities and equipment over the planned discharge timeframe.
- The IAEA notes that the systems and processes in place to control the discharges of ALPS treated water are robust and more than adequate for the expected low doses and the low risk arising from the discharge process.
- Furthermore, the IAEA has noted that the pre-service inspections conducted by the NRA are sufficient to ensure the installation and operation of relevant facilities and equipment is consistent with the NRA-approved Implementation Plan; and that the approach for incorporating oversight of the relevant facilities and equipment into the operational inspection programme conducted by NRA at FDNPS is appropriate.

3.3. Characterization of the Source

3.3.1 Background

In accordance with the authorization process for discharges described in GSG-9 [9], “a pre-operational analysis should be carried out to identify the inventories of radionuclides that would result in discharges during the operation of a facility or the conduct of an activity...” This characterization, and the subsequent identification of the main exposure pathways, ensures an adequate assessment of the exposure of the representative person. Further, the regulatory body is recommended to “evaluate whether the models and assumptions used (for this characterization, and the subsequent identification of the main exposure pathway) are appropriate” to ensure an adequate assessment of the exposure of the representative person.

The need for a detailed characterization of the discharges, as part of the dialogue between the regulatory body and the applicant on the process to be followed by an applicant seeking an authorization for discharges, should depend on the expected magnitude of the dose to members of the public, in accordance with a graded approach. In accordance with RS-G-1.8 [16], as part of pre-operational studies performed to determine the impacts of the source, including the prediction of doses to the public from discharges to the environment, it is necessary to determine the expected activity inventory and radiation characteristics of the source; the types and activities of radionuclides that will be discharged, their physical and chemical forms, the methods and routes of discharge and the rates of discharge.

3.3.2 Review and Assessment

TEPCO has developed an appropriately conservative characterisation of the source. Details are provided in its REIA Section I-4 (Inventory Assessment) and I-5 (Selection of nuclides) for the methodology for selecting the radionuclides to be measured and assessed prior to discharge of each batch of ALPS treated water. This methodology is comprised of 5 steps and can be summarised as follows. An overview is presented in Figure 3.11.

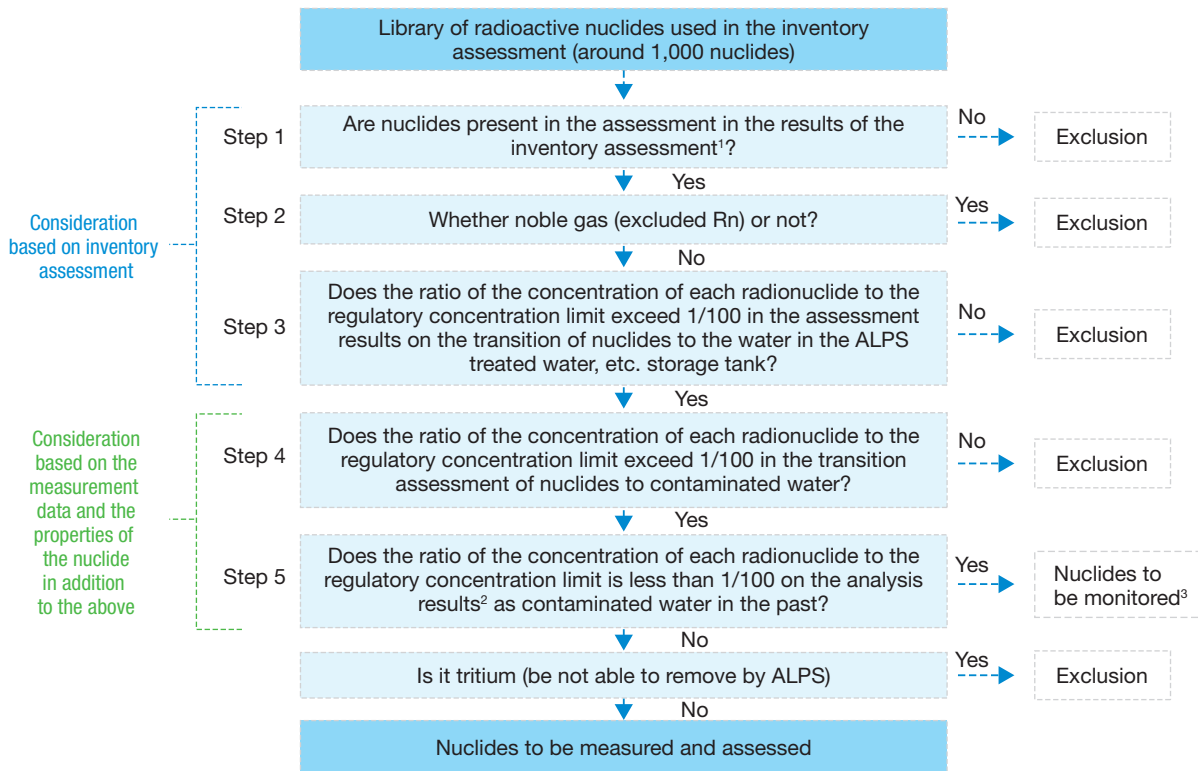

Figure 3.11. Overview of methodology used by TEPCO to select radionuclides to be measured and assessed prior to discharge

Overview of methodology used by TEPCO to select radionuclides to be measured and assessed prior to discharge

Steps 1-3 were based on calculations performed by TEPCO:

- Step 1: The radionuclide inventories in Units 1, 2 and 3 at FDNPS 12 years after cold shutdown were evaluated. For the fuel, an initial inventory for each reactor was estimated by multiplying the uranium fraction per ton and the percentage masses of each element by a nominal mass of the core. ORIGEN¹ was then used to assess the burnup of each fuel bundle from the time of loading until the time of the accident (including consideration of mixed-oxide fuel in Unit 3). Fission products resulting from the nuclear fission of ²³⁵U, nuclides resulting from the absorption of neutrons by ²³⁸U, such as isotopes of plutonium, and nuclides produced by when fission products capture neutrons, such as ¹³⁴Cs, were assessed using this code. Activation of materials comprising each reactor structure was simulated over the entire commercial operational history of each unit. Following these calculations, all radionuclides in the standard ORIGEN library (around 1,000) determined to have activities less than 1 Bq per reactor core – essentially all short-lived radionuclides – were not further considered.
- Step 2: Noble gases (that cannot be present in contaminated water) were eliminated from the radionuclide inventories evaluated in step 1.
- Step 3: The hypothetical estimated maximum possible activity concentrations of all radionuclides in the treated water etc. stored in the tanks at FDNPS water were estimated and compared to respective regulatory limits. It was assumed that the entire radionuclide inventories of three reactors (as evaluated in step 1) were dissolved in the current total volume of treated water etc. at

¹ ORIGEN is a widely used and well validated software tool for simulating ingrowth, decay, and activation in PWR and BWR reactors. This software was developed by the Oak Ridge National Laboratory in the United States.

FDNPS (1,330,000 m3). Any radionuclides for which the resulting activity concentrations were less than 1% of the respective regulatory limit were eliminated from the radionuclide inventories evaluated in step 1.

Steps 4 and 5 incorporated the results of measurement and analyses for further down-selection:

- Step 4: The potential for radionuclides to transfer from the reactors to the contaminated water was assessed and the resulting activity concentrations were compared to respective regulatory limits. Radionuclides having a similar chemical form in water were first grouped. Parent radionuclides and short-lived progeny were assumed to be in equilibrium (after the 12-year cool down period), except Zr-93 and Nb-93 (as they have not reached equilibrium as of 2022). A representative radionuclide was defined for each group (determined by contribution to dose) and a “relative ratio” was calculated for each radionuclide (the ratio of its activity as evaluated in step 1 to the respective regulatory limit, itself divided by the same ratio for the representative radionuclide). Where the relative ratio was less than 0.01, the radionuclide was eliminated from the radionuclide inventories evaluated in step 1.

A transfer coefficient was then calculated for the representative radionuclide in each group (from the periodic table): the ratio of its maximum measured activity concentration, decay corrected to the time of the accident, divided by its activity as evaluated in step 1. TEPCO and laboratories that it has contracted has carried of a broad range of radionuclide-specific measurements over many years since 2011 of samples taken from different points in the contaminated water processing stream. These include long-lived, high-yield fission and neutron activation products, and isotopes of uranium and transuranics, including isotopes of Np, Pu, Am, and Cm. The activity of each radionuclide remaining following the steps above was multiplied by the transfer coefficient for the group in order to estimate its maximum estimated activity concentration. Any radionuclide having an activity concentration less than 1% of the respective regulatory limit was eliminated from the radionuclide inventories evaluated in step 1. Radionuclides not assigned to a group were assessed individually.

- Step 5: The remaining 37 radionuclides were categorised:
 - Tritium to determine the discharge flow rate and dilution factor,
 - 29 radionuclides to be measured and assessed against respective regulatory limits, plus tritium, prior to discharge of each batch of ALPS treated water (source monitoring).
 - Six radionuclides that have never been detected but will nevertheless be regularly monitored (but not for each batch).

The 30 radionuclides to be measured and assessed, identified by this methodology and the subsequent review by NRA, are shown in Table 3.2.

Table 3.2. RADIONUCLIDES INCLUDED in TEPCO’s ALPS TREATED WATER SOURCE TERM

³ H	⁷⁹ Se	^{125m} Te	¹⁵¹ Sm	²³⁸ Pu
¹⁴ C	⁹⁰ Sr	¹²⁹ I	¹⁵⁴ Eu	²³⁹ Pu
⁵⁴ Mn	⁹⁰ Y	¹³⁴ Cs	¹⁵⁵ Eu	²⁴⁰ Pu
⁵⁵ Fe	⁹⁹ Tc	¹³⁷ Cs	²³⁴ U	²⁴¹ Pu
⁶⁰ Co	¹⁰⁶ Ru	¹⁴⁴ Ce	²³⁸ U	²⁴¹ Am
⁶³ Ni	¹²⁵ Sb	¹⁴⁷ Pm	²³⁷ Np	²⁴⁴ Cm

The potential presence of progenies in the source term, even those with very short half-lives, was assessed by TEPCO using the methodology described above. The decay products of the radionuclides that are included in the source term are given in Table 3.3. Most were eliminated at step 4 but ⁹⁰Y (2.6 d half-life, progeny of ⁹⁰Sr) and ^{125m}Te (57 d half-life, progeny of ¹²⁵Sb) were not and have been included by TEPCO in its source monitoring plan. According to this plan, levels of both radionuclides will be assessed through measurement of their respective parents and assuming equilibrium.

Table 3.3. Decay products of the radionuclides included in the source term

Radionuclide	Decay product	Half-life of decay product	Radionuclide	Decay product	Half-life of decay product
³ H	stable	-	¹³⁷ Cs	^{137m} Ba	2.6 min
¹⁴ C	stable	-	¹⁴⁴ Ce	¹⁴⁴ Pr	17.3 min
⁵⁴ Mn	stable	-	¹⁴⁷ Pm	¹⁴⁷ Sm	1.06E11 a
⁵⁵ Fe	stable	-	¹⁵¹ Sm	stable	-
⁶⁰ Co	stable	-	¹⁵⁴ Eu	stable	-
⁶³ Ni	stable	-	¹⁵⁵ Eu	stable	-
⁷⁹ Se	stable	-	²³⁴ U	²³⁰ Th	75400 a
⁹⁰ Sr	⁹⁰ Y	2.66 d	²³⁸ U	²³⁴ Th	24.1 d
⁹⁰ Y	stable	-	²³⁷ Np	²³³ Pa	26.98 d
⁹⁹ Tc	stable	-	²³⁸ Pu	²³⁴ U	245500 a
¹⁰⁶ Ru	¹⁰⁶ Rh	30.1 s	²³⁹ Pu	²³⁵ U	7.03E8 a
¹²⁵ Sb	stable	-	²⁴⁰ Pu	²³⁶ U	2.34E7 a
^{125m} Te	stable	-	²⁴¹ Pu	²⁴¹ Am	432 a
¹²⁹ I	stable	-	²⁴¹ Am	²³⁷ Np	2.1E6 a
¹³⁴ Cs	stable	-	²⁴⁴ Cm	²⁴⁰ Pu	6561 a

TEPCO has also identified additional radionuclides that will be monitored routinely to ensure a conservative approach is adopted. These radionuclides were excluded by the methodology described above but are not subject to removal by ALPS (with the exception of ^{113m}Cd) and have been detected previously in samples of contaminated water from FDNPS. Therefore, while unlikely to be present in significant quantities, TEPCO nonetheless will monitor for the presence of these radionuclides on a periodic basis (e.g., not every batch). These additional radionuclides are listed in Table 3.4.

Table 3.4. Radionuclides to be monitored at intervals

³⁶ Cl	^{93m} Nb	⁹⁴ Nb	⁹³ Mo	^{113m} Cd	¹³³ Ba
------------------	-------------------	------------------	------------------	--------------------	-------------------

The efficiency of ALPS and the other systems designed to reduce activity concentrations of radionuclides in contaminated water at FDNPS is not considered directly at any point in this methodology though, undoubtedly, the activity concentrations of radionuclides targeted for removal by ALPS would be expected to be lower following treatment. Furthermore, the Task Force noted that considering the efficiency or effectiveness of the ALPS system was unnecessary as every batch is analysed for all radionuclides in the source term (see Table 3.2) plus additional radionuclides to ensure a conservative approach; therefore, the control for the system is not on the performance of the ALPS process but rather a 100% verification of all batches prior to their discharge.

This methodology to characterize the ALPS treated water source term has been reviewed and approved by the NRA. Some minor changes were implemented based on this review, for example ^{55}Fe , an important activation product in nuclear waste in the initial period after shut down, which, along with ^{129}I , ^{14}C and ^{79}Se , has been identified in the REIA as an important contributor to ingestion doses for children and infants (relatively speaking considering that the annual committed effective ingestion dose is very low for all age groups, and less than $0.04 \mu\text{Sv}$ per year), was added and $^{113\text{m}}\text{Cd}$ and ^{243}Cm were removed.

The source characterisation was fundamentally revised over the course of the IAEA review, in part in response to feedback from the Task Force. Previously the approach adopted by TEPCO was overly conservative in an unrealistic manner – after considering Task Force feedback, an alternative, appropriately conservative approach was adopted. Most significantly, TEPCO changed the underlying philosophy, from identifying the “selection of radionuclides subject to removal by ALPS” to selecting those that should be “subject to measurement and assessment with vigorous verification”. This is consistent with the requirements for characterization of discharges set out in the relevant IAEA International Safety Standards (e.g., GSG-9 para 5.20). Thus, the characterization of the source directly informs TEPCO’s plan for source monitoring and the selection of analytical methods for each identified radionuclide (see Section 3.5).

NRA provided evidence to the Task Force that, from their perspective, no significant radionuclides have been excluded from the current ALPS treated water source term. The evidence provided by the NRA included independent calculations of doses associated with the exposure pathways used to set the regulatory concentration limits and exposure pathways considered in the REIA and comparisons of the results of those two calculations. The Task Force discussed with NRA alternative characterization approaches that could be considered for determining the source term, if TEPCO makes further revisions in the future.

The exposure pathway used to set the regulatory concentration limits by NRA was explained to the Task Force as:

“Regulatory concentration limit is the standard for the release of radioactive waste into the environment, which is specified for each radionuclide in the “Notification Establishing Dose Limits, etc. Based on the Provisions of the Regulations, etc. Concerning the Refining Business of Nuclear Source Material or Nuclear Fuel Material.” It is specified that if water equal to regulatory concentration limit is continued to be [consumed] daily 2L for a lifetime (70 years in adults), the mean exposure dose will be 1mSv/year.”

Furthermore, through its own independent sampling and analysis activities, neither the IAEA, nor the participating third-party laboratories, detected any additional radionuclides (i.e., radionuclides beyond what is included in the source term) at significant levels. Part IV of this report has additional information regarding the current results of the IAEA’s corroboration activities.

3.3.3 Conclusions

The IAEA has concluded that the approach and activities undertaken by TEPCO and NRA are consistent with the relevant international safety standards included under this section of the report. Further detailed findings are included below:

- The IAEA has accepted the rationale presented by TEPCO for a sufficiently conservative, yet realistic, source term. TEPCO’s approach in characterizing the source was atypical in that it did not use the radionuclides potentially contributing most to dose as a starting point. However, as noted previously all relevant radionuclides were still included and given the activities involved it is fit for purpose.

- The underlying philosophy changed during the period of its review, from identifying the “selection of radionuclides subject to removal by ALPS” to selecting those that should be “subject to measurement and assessment with vigorous verification” – this new approach is consistent with the requirements for characterization of discharges set out in the relevant IAEA International Safety Standards (e.g., GSG-9 para 5.20).
- IAEA notes that many radionuclides included in the source term will never be detected in ALPS treated water. Only the “7 major radionuclides” (^{134}Cs , ^{137}Cs , ^{60}Co , ^{125}Sb , ^{106}Ru , ^{90}Sr , ^{129}I) plus tritium, ^{14}C and ^{99}Tc can be routinely detected in samples of ALPS treated water. There would therefore appear to be ample scope to relax the conservatism of the source term in the future as operational experience is gained.
- The importance of maintaining a strong connection between the characterization of the source and source and environmental monitoring programmes has already been stated. Important information will become available as the monitoring database grows, which will ensure that *a priori* assumptions can be verified and that the REIA, including the characterization of the source can be refined as appropriate.

3.4. Radiological Environmental Impact Assessment

3.4.1 Background

A prospective Radiological Environmental Impact Assessment (REIA) is an important tool in helping licensees and regulatory bodies estimate and control the radiological effects on the public and the environment from radioactive discharges² from activities and facilities. A REIA can serve multiple purposes, including establishing the initial basis for authorization with respect to the protection of the public and the environment, and as an important input into the process of authorizing controlled discharges.

The aim of a prospective REIA is to determine whether the planned facility or activity complies with current legislative and regulatory requirements on the protection of the public and the environment under all reasonably foreseeable circumstances. Such a prospective assessment includes the consideration of exposures expected to occur in normal operation and potential exposures due to accidents that are identified. The REIA should be as simple as possible, but as complex as necessary to achieve this aim.

GSR Part 3 [8] sets requirements for establishing a governmental, legal and regulatory framework for safety for the regulation of activities that give rise to radiation risks. These requirements are applicable to both the regulatory body and registrants or licensees. These requirements include the establishment of dose limits for workers and the public, optimization of protection and safety of the public, including dose constraints applied to public exposure in planned exposure situations, establishment of an authorization process, as well as requirements for operational performance. The concept of radiological environmental impact assessment is included as part of the safety assessment for facilities and activities. Paragraph 3.31 of GSR Part 3 [8] states that:

² A discharge is a planned and controlled release of gaseous, aerosol or liquid radioactive substance to the environment

“Safety assessments shall be conducted...so as:

- (a) To identify the ways in which exposures could be incurred...;
- (b) To determine the expected likelihood and magnitudes of exposures in normal operations and, to the extent reasonable and practicable, to make an assessment of potential exposures”

The responsibilities placed on the registrants or licensees when applying for an authorization for discharges to the environment are given in GSR Part 3 [8]. Paragraph 3.9 of GSR Part 3 [8] states that:

“Any person or organization applying for authorization:

- (e) Shall, as required by the regulatory body, have an appropriate prospective assessment made for radiological environmental impacts, commensurate with the radiation risks associated with the facility or activity”

and paragraph 3.15 of GSR Part 3 [8] states that:

“Registrants and licensees:

- (d) Shall, for the sources for which they are authorized and for which the regulatory body requires a prospective assessment to be made for radiological environmental impacts, conduct such an assessment and keep it up to date;“

As part of the process of the authorization of discharges, Paragraph 5.43 of GSG-9 [9] states that, for setting discharge limits, the results of a prospective environmental impact assessment conducted in accordance with the requirements of the regulatory body are required to be considered. Guidance on REIA for facilities and activities that should be conducted during or prior to siting, design and construction stages is given in international safety standards Series No. GSG-10.

As part of undertaking a prospective assessment of the radiological environmental impacts, paragraph 3.132 of GSR Part 3 [8] states:

”Registrants and licensees, in cooperation with suppliers, in applying for an authorization for discharges, as appropriate:

- (a) Shall determine the characteristics and activity of the material to be discharged, and the possible points and methods of discharge;
- (b) Shall determine by an appropriate pre-operational study all significant exposure pathways by which discharged radionuclides could give rise to exposure of members of the public;
- (c) Shall assess the doses to the representative person due to the planned discharges;
- (d) Shall consider the radiological environmental impacts in an integrated manner with features of the system of protection and safety, as required by the regulatory body;
- (e) Shall submit to the regulatory body the findings of (a)–(d) above as an input to the establishment by the regulatory body, ... of authorized limits on discharges and conditions for

their implementation.”

In applying the principle of optimization of protection and safety in the design, planning, operating and decommissioning of a source, paragraph 3.126 of GSR Part 3 [8] states:

“Registrants and licensees ..., shall take into account:

(a) Possible changes in any conditions that could affect exposure of members of the public, such as changes in the characteristics and use of the source, changes in environmental dispersion conditions, changes in exposure pathways or changes in values of parameters used for the determination of the representative person;

(c) Possible buildup and accumulation in the environment of radioactive substances from discharges during the lifetime of the source;

(d) Uncertainties in the assessment of doses, especially uncertainties in contributions to doses if the source and the representative person are separated in space or in time.”

GSG-9 [9] and GSG-10 [11] provide recommendations on undertaking a REIA to meet the requirements established in GSR Part 3 [8].

Figure 3 of GSG-9 (see Section 3.1), shows the steps in the process for authorization of discharges. This includes a prospective assessment of doses to the public; such an assessment is usually called a Radiological Environmental Impact Assessment (REIA).

Paragraph 5.13 of GSG-9 [9] states that:

“The regulatory body should establish the process to be followed by an applicant seeking an authorization for discharges once the need for an authorization for discharges has been established. The steps of the authorization process may be as follows:

(d) The applicant should assess the doses to the representative person. This may involve a number of iterations, starting with a simple, cautious generic assessment and, if necessary, a more detailed, site-specific study.

(e) The applicant should submit the results of the assessment to the regulatory body. The regulatory body should evaluate whether the models and assumptions used by the applicant are appropriate, should compare the results of the assessment with dose limits and dose constraints, and should evaluate whether the assessed doses are in accordance with the need to provide optimized protection of the public.” GSG-10 [11] goes on to say ‘In general, the authorization of a nuclear facility will require a high degree of complexity, where for an activity or facility operating with a small inventory of radionuclides, a simpler analysis may be justified.’ Table 3.5 gives examples of the factors to be considered when considering the level of complexity needed for a REIA.

GSG-10 provides a framework for undertaking a REIA and provides information on the factors that are important in determining the need for and the complexity of the REIA within an authorization process. GSG-10 states that ‘The applicant should consider these factors when submitting an application to the regulatory body for review and agreement. For certain facilities and activities, the level of detail of the assessment can be defined a priori by the regulatory body.’

Table 3.5. Examples of the factors to be considered when considering the level of complexity needed for an REIA (reproduction of Figure 1 in GSG-10 [11]).

Factor	Element
Characteristics of the facility or activity	<p>Source term</p> <ul style="list-style-type: none"> – Radionuclides – Quantity (both activity and mass/volume) – Form (chemical/physical make-up) – Geometry (size, shape, height of release) – Potential for release: the source term differs significantly for normal operation and for accidents Expected doses from normal operation or projected doses from potential exposures – Preliminary assessments or previous assessments for similar facilities Safety characteristics of the activity or facility – Types of safety barrier and engineering feature present in the design – Potential for severe accidents
Characteristics of the location	<p>Characteristics of the facility site relating to dispersion of radionuclides in the environment (e.g. geology, hydrology, meteorology, morphology, biophysical characteristics)</p> <p>Presence and characteristics of receptors (e.g. demography, living habits and conditions, flora and fauna)</p> <p>Exposure pathways</p> <p>Land use and other activities (e.g. agriculture, food processing, other industries)</p> <p>Characteristics of other installations in the vicinity and possible natural and human induced external events (e.g. earthquakes, flooding, industrial accidents, transport accidents)</p>
Characteristics of the authorization process for the particular activity or facility	<p>Requirements or regulations (licensing requirements)</p> <p>Stage of the authorization process</p>

^a The list provided here is not exhaustive, and judgement on the significance of these factors when selecting the type of assessment will need to be made by experts in nuclear and radiation safety in the applicant's organization and by the national regulatory body.

Potential exposures

Under Requirement 9 in GSR Part 3 [8] on the responsibilities of registrants and licensees for protection and safety in planned exposure situations, paragraph 3.15 states:

“Registrants and licensees:

(e) Shall assess the likelihood and magnitude of potential exposures, their likely consequences and the number of individuals who may be affected by them...”

Protection of the environment

Paragraph 2.4 of GSG-8 [10] expands on this requirement with the recommendation that “In planned exposure situations, exposure at some level can be expected to occur. If exposure is not expected to occur with certainty but could result from an anticipated operational occurrence or accident or owing to an event or a sequence of events that may potentially occur but is not certain to occur, this is referred to as ‘potential exposure’. The magnitude and extent of potential exposure can usually be predicted. Both exposures expected to occur, and potential exposures can and should be taken into account at the planning or design stage.”

The requirements on the system of protection and safety in GSR Part 3 [8] generally provide for appropriate protection of the environment from harmful effects of radiation. Paragraph 1.32 of GSR Part 3 [8] states that:

“In a global and long term perspective, protection of people and the environment against radiation risks associated with the operation of facilities and the conduct of activities – and in particular, protection against such risks that may transcend national borders and may persist for long periods of time – is important for achieving equitable and sustainable development”.

Paragraph 1.33 of GSR Part 3 [8] states that:

“... international trends in this field show an increasing awareness of the vulnerability of the environment. Trends also indicate the need to be able to demonstrate (rather than to assume) that the environment is being protected against effects of industrial pollutants, including radionuclides, in a wider range of environmental situations, irrespective of any human connection. This is usually accomplished by means of a prospective environmental assessment to identify impacts on the environment, to define the appropriate criteria for protection of the environment, to assess the impacts and to compare the expected results of the available options for protection. Methods and criteria for such assessments are being developed and will continue to evolve.”

In many instances, it can be concluded, on the basis of evidence such as experience or simplified analysis, that specific consideration of effects in the environment is not necessary. This may not be the case in all situations, and the explicit consideration of the protection of the environment may be required by the regulatory body and depends on the characteristics of the facility or activity and the environmental conditions under consideration (paragraph I-2 in GSG-10 [11]). In other cases, explicit consideration of the protection of the environment is captured in national legislation. A methodology for the explicit assessment of the radiation impacts on flora and fauna, which can be used in accordance with national or international regulatory frameworks for the protection of the environment, is presented as an example in Annex I of GSG-10 [11]. The need for the explicit assessment of the protection of flora and fauna is subject to the national regulations.

3.4.2 Review and Assessment

In line with the Basic Policy issued by the Government of Japan in April 2021, TEPCO undertook a REIA³ for the discharge of ALPS treated water. Assessments of doses to the public and to flora and fauna have been performed. The REIA forms part of the Implementation Plan submitted to NRA as its application for authorization of the discharges of ALPS treated water.

³ Unless otherwise specified, any reference to the REIA in this section refers to the latest version submitted by TEPCO in February 2023 and approved by the NRA in May 2023.

The review of the REIA was considered within the framework of the authorization process for discharges described in Section 3.1 and illustrated in Figure 3.1. This process includes the applicant “presenting the measures to be used for the optimization of protection and safety of the public, having given consideration to measures for keeping the exposures as low as reasonably achievable and having taken into account all relevant factors” as stated in paragraph 5.13 in GSG-9. During the two missions to TEPCO (see Annex 1), the Task Force held detailed discussions about all aspects of the work undertaken by TEPCO in producing the REIA to support their application for authorization of the discharge of ALPS treated water, including the results. Following the review of the initial draft REIA during the first mission to TEPCO in February 2022, the Task Force acknowledged the extensive work undertaken by TEPCO. Several key assumptions in the REIA regarding the behaviour of radionuclides in the environment and the prospective estimates of the dose to members of the public were discussed. The Task Force identified that a more detailed and thorough written description of the modelling, assumptions, and data was needed to provide evidence that the assumptions made are appropriate and sufficiently conservative.

The Task Force discussed with TEPCO the importance of documenting their approach for the optimization of protection, the parameters to be varied and the factors to be considered, and that TEPCO notes how interested parties are engaged in the process. The Task Force emphasized that TEPCO should explain the impact of reducing doses (to public and environment) on other factors valued by interested parties (economic, societal and environmental factors). TEPCO should also make it clear why the proposed approach is optimal at this point in time. The Task Force noted that this clarity could help TEPCO when engaging with interested parties in the future and communicating about any potential changes with the discharge approach. It was discussed that understanding the impact of varying different key parameters, such as the discharge rate, on relevant factors considered in the optimization of protection for the FDNPS site would help to identify the optimal parameters for the discharge of ALPS treated water and thus the optimal dose to members of the public.

In line with SF-1, GSR Part 3 and GSG-9, the Task Force requested TEPCO to draft a chapter in the REIA describing the optimization of protection in a qualitative manner for the discharge of ALPS treated water. The chapter would ideally include a written explanation of annual discharges that meet the dose constraint; options for reducing dose below the dose constraint; and impacts on other factors from reducing doses (to public and environment). The Task Force noted the overriding importance placed on current societal concerns in the Basic Policy for the discharge of ALPS treated water. The Task Force also suggested that TEPCO calculates and includes upper limits of annual discharges (corresponding to the dose constraint) in their qualitative description of the optimization process.

In response, TEPCO performed these calculations and showed that a significantly higher discharge rate could be used while still remaining within the dose constraint established by NRA.

In July 2022, TEPCO published a revised REIA that addressed many of the comments made by the Task Force but had not yet incorporated a revision to the source term which was being further developed at that time (see Section 3.3). In February 2023, TEPCO prepared a final version of the REIA taking into account a new source term: this version also addressed the additional relevant comments made by the Task Force during the 2nd mission in November 2022. TEPCO has included a chapter in the REIA that provides a description of optimization of protection and safety in relation to the discharge of ALPS treated water.

In February 2023, the revised version of the REIA was submitted to NRA as part of an amended Implementation Plan and was approved by the NRA in May 2023.

Approach adopted by TEPCO for the REIA for the discharge of ALPS treated water

Figure 3.12 summarizes the components of a REIA for the public for normal operation of a facility or activity. In general terms, the first element of the assessment is to characterize the source of radiation as it relates to public exposure. Next, the dispersion and transfer of radionuclides in the environment is considered to estimate activity concentrations in food and the environment. Doses are assessed for a representative person, who is a generic person that represents the more highly exposed individuals in the population, taking into account all relevant pathways of radiation exposure.

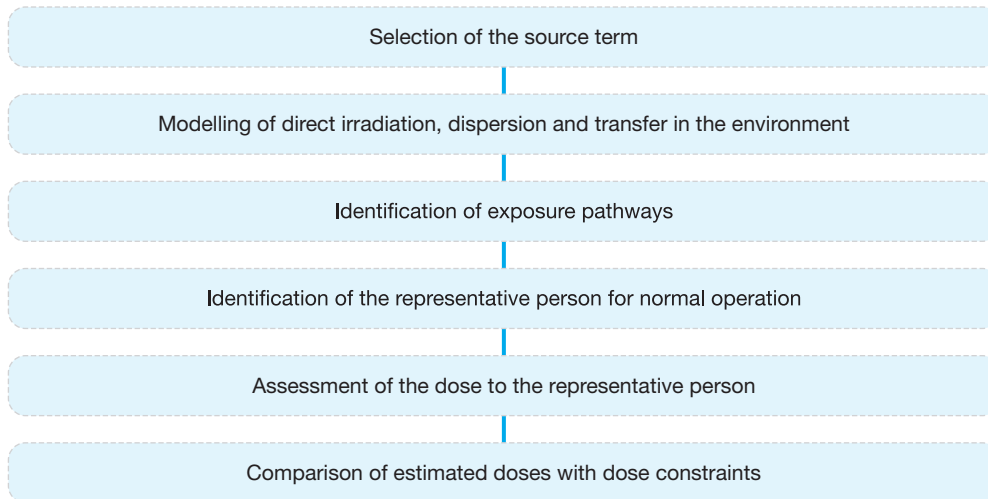

Figure 3.12. Components of a REIA for the public for normal operation of a facility or activity (taken from GSG-10)

The dose to the representative person is compared with a dose constraint for a specific facility or activity. The dose constraint is used as a starting point within the process of optimization and to find a level of discharges that is optimal in terms of protection of the public (as discussed in Section 3.1).

A generic methodology for assessing exposure of flora and fauna is provided in GSG-10 [11] and it is based on the ICRP approach for the protection of the environment [12, 13]. (Figure 3.13 (fig. I-2 of IAEA GSG-10 [11]) shows the components of a generic assessment for protection of flora and fauna to illustrate the elements of the assessment, the endpoint being the assessment of dose rates to reference animals and plants for comparison with Derived Consideration Reference Levels (DCRL) [12]. The DCRLs define bands of dose rates within which certain effects have been noted, or might be expected, the values are specified in mGy per day with a lower and upper value for each reference animal and plant. As for the assessment of doses to the public, the behaviour of radionuclides in the environment and the estimation of activity concentrations in the environment are needed. In accordance with the concept of representative organisms, the dose rate to be estimated in the assessment of the impact on populations of flora and fauna is the dose rate that is characteristic of the dose rates received by a group of individual organisms located in a reference area around the source, normally around the discharge point, where the highest exposures may typically occur. The dose rate characteristics for this group are estimated using, for example, the average activity concentrations within this reference area. GSG-10 [11] states that “Although ecological characteristics may differ, in general, an area surrounding the discharge point of the order of 100 – 400 km² could be used for most exposure scenarios relating to normal operation of activities or facilities”. TEPCO has used a sea area of 10 x 10 km around the discharge point for its calculations in the REIA (i.e., 100 km²) and the average activity concentration in the sea in this area.

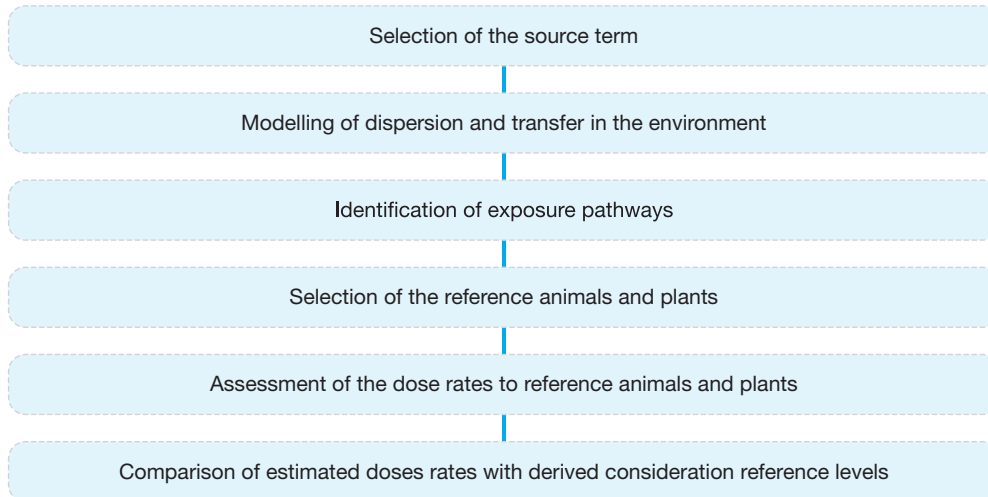

Fig 3.13. Components of a generic assessment for protection of flora and fauna in normal operation (taken from GSG-10 [11])

The dose rates to reference animals and plants (RAP) are compared with Derived Consideration Reference Levels (DCRL).

The REIA⁴ undertaken by TEPCO for the discharge of ALPS treated water has been undertaken in line with the methodology described in IAEA GSG-10 [11]. Assessments of doses to the public and to flora and fauna have been performed.

The modelling approach used in the REIA [15] is not identical but is similar to the methodology described in IAEA [26]. A similar generic-type model is applied in the REIA. Some site-specific models have been introduced, in particular a marine dispersion model for the coastal waters around the FDNPS, as well as country-specific lifestyle data, such as occupancy of beaches and seafood intakes. The generic-type approach in IAEA [25] was developed such that the estimated doses are generally likely to be overestimated.

Each step of the REIA [15] performed by TEPCO is discussed in more detail below.

Selection of a source term

The first step of the REIA is the selection of the source term. The characterization of the source term is discussed in Section 3.3. The source term should reflect the radionuclides that are reasonably expected to be present in the ALPS treated water at the time of the actual discharge. As input to the REIA, IAEA international safety standards recommend that discharges be expressed in terms of Bq/year for each radionuclide.

TEPCO described the procedures, methodologies and assumptions used to select the source terms used in the REIA and to characterize the discharge; this is covered in detail in Section 3.3. TEPCO considered 3 source terms based on the nuclide composition and activity concentrations in 3 tank groups, namely K4 (before agitation installation), J1-C and J1-G. The water in the K4 tank group has been treated by one treatment process using the performance of ALPS to make the sum of the ratios to regulatory concentrations limits less than 1. On the other hand, the water in the J1-C and J1-G tank groups have been treated twice to reach the requirements of the sum of the ratios to the regulatory concentration limit being less than 1. The compositions of the radionuclides of the three tank groups are considered typical of the composition

⁴ Unless otherwise specified, any reference to the REIA in this section refers to the latest version submitted by TEPCO in February 2023 and approved by the NRA on 10 May 2023.

of concentrations in ALPS treated water. The source term characterization is described in more detail in Section 3.3 and in the REIA. The source term has been calculated by TEPCO in terms of the Bq per year of each radionuclide discharged.

There have been several iterations of the source term while the IAEA's safety review has been conducted; this is expected and encouraged and is consistent with an iterative approach as noted above. The Task Force noted that TEPCO should assess whether the related assumptions in the REIA (i.e., assumptions that are dependent on the source term) remain valid after each revision. TEPCO has confirmed that the revised source term has not had an impact on the assumptions made in the REIA and therefore the assumptions remain valid.

The Task Force noted that as a consequence of revising the source term in November 2022, the radionuclides contributing most to the dose to the public changed. In particular, ^{14}C and ^{129}I are now in the top three radionuclides contributing most to the overall dose to the representative person from the discharge of the ALPS treated water. While the overall estimated dose from the source term remains extremely low, TEPCO has included further information on the radiological impact of ^{14}C and ^{129}I from the discharges of ALPS treated water and a specific discussion on the behaviour of ^{14}C and ^{129}I in the environment in the REIA. This information is included in the February 2023 revision of the Implementation Plan.

Behaviour of released radionuclides in the aquatic environment

The second main step of the REIA is the modelling of dispersion and transfer of radionuclides in the environment. The REIA provides a description of how TEPCO has considered the transfer of the radionuclides released into the marine environment, the models and parameter values used and the assumptions made in this regard. Important aspects of the behaviour of radionuclides in the marine environment are dispersion in the sea, accumulation in the seabed and beach sediments over the planned period of the ALPS treated water discharge, and transfer to marine organisms and foods.

In the REIA [15], TEPCO has used a marine dispersion model taking into account the meteorological and hydrological conditions in the vicinity of the site. The model is called Regional Ocean Modelling System (ROMS, www.myroms.org), and it was validated using environmental monitoring measurements for the caesium concentrations in seawater after the FDNPS accident.

This model validation is in accordance with paragraphs 5.2 and 5.3 of GSG-10 [11] that state that the models used for dispersion and transfer of radionuclides in the environment should be appropriate for the situation in which they are being applied. The models should also be validated, when possible, comparing the results of model calculations with actual data resulting from measurements for similar exposure scenarios.

TEPCO used the ROMS model to calculate the activity concentrations in the sea based on the meteorological and oceanographic conditions in 2014 and 2019. Although there is no large difference between the results for the 2 years, TEPCO chose to use the results based on the 2019 data as the predicted concentrations around the FDNPS were slightly higher. In running the diffusion simulation, no account was taken of removal processes, such as sedimentation. TEPCO states that the simulations of dispersion in the sea were made for tritium, then calculations for the concentrations of the other radionuclides in the source term were conducted using the relative ratios of the radionuclides in each source term considered. This approach is based on the assumption that all the radionuclides in the discharged ALPS treated water are water soluble and will disperse together.

The Task Force had several detailed discussions with TEPCO about the modelling approach it has adopted for the accumulation of radionuclides in sediments and how the activity concentrations predicted are used to assess doses to the public and flora and fauna.

When radionuclides are continuously discharged to the sea, they can be absorbed by suspended matter and deposited on the seabed. This is a continuous process that can lead to an accumulation of radionuclides in the seabed sediments over time. At some point they accumulate in the sea environment over time up to the point at which equilibrium conditions can be assumed between the sea water and the seabed sediments (illustrated in Figure 3.14). The time when this equilibrium will be approached will differ for each radionuclide and may occur shortly after the start of discharges or not until many years later.

Paragraph 5.22 of GSG-10 [11] explains that estimates of radiation doses from the discharges to the environment should be calculated for the time at which the highest radiation exposure is expected. The activity concentrations in environmental media that are used to estimate these radiation doses need to be representative of the conditions when accumulation can be assumed to be a maximum. This will be the time when equilibrium has been reached between the seawater and the seabed for all the radionuclides that accumulate in seabed sediments.

This accumulation in marine sediments is often considered using a dynamic model that is run over the period of the discharges from a nuclear facility and the dose from marine exposure pathways is calculated in the last year of discharge which is considered to be the highest over the discharge period. However, for the assessment of the radiological impact of accumulation of radionuclides in seabed sediments, TEPCO has applied relatively simple models in the REIA. The build-up of radionuclides in sediments with time is not explicitly simulated; however, the approach taken ensures that the resulting doses are not underestimated.

For the estimation of activity concentration in sediments, TEPCO has assumed that there is a direct equilibrium between radionuclide concentration in seawater and sediments from the start of the discharges, which is a conservative assumption with respect to the assessment of external exposures from sediments.

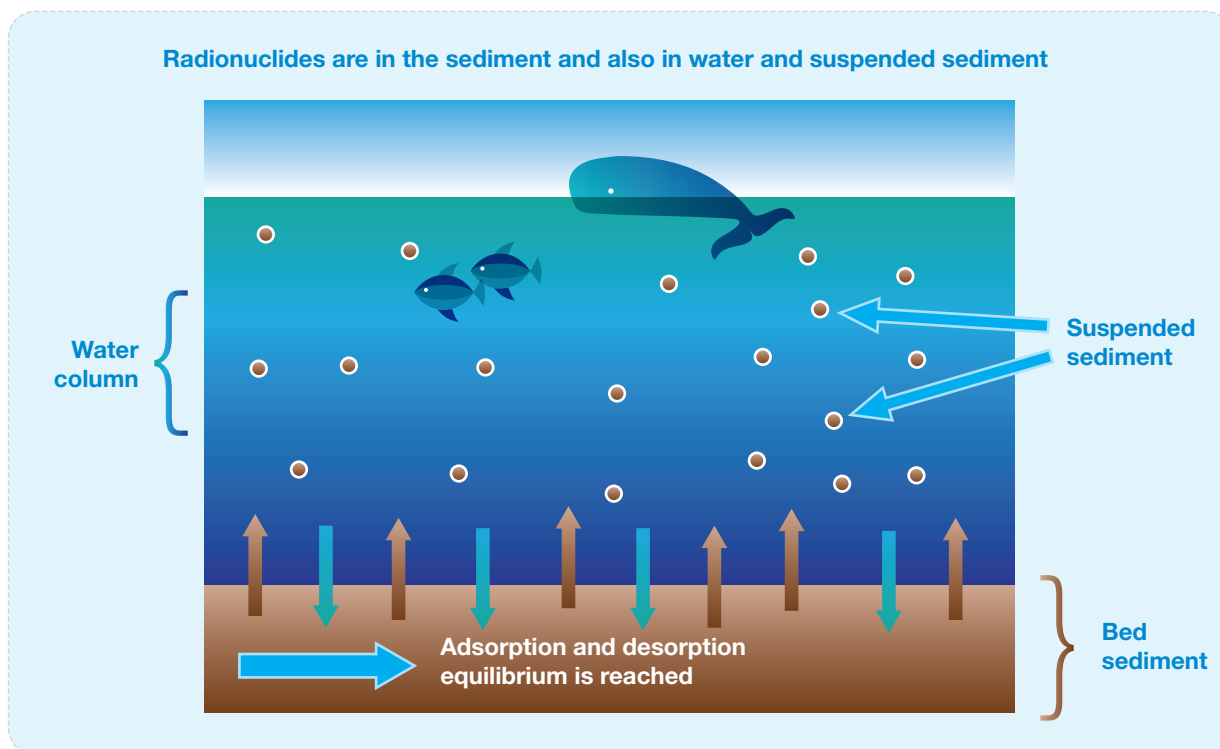

Fig 3.14: Behaviour of radionuclides in seawater and sediments

TEPCO has also built in other conservative assumptions into the dose calculations from marine exposure pathways. For dose pathways linked directly to seawater, TEPCO explained that it has been assumed that the concentration in seawater is not depleted by transfer to the sediments, and it stays at this level throughout the discharge period.

For dose pathways relating to sediments, TEPCO has conservatively assumed that there is dynamic equilibrium between seawater and sediments from the first year that discharges start, even though equilibrium would not actually be expected to occur for a number of years after discharges start, as discussed above. For the estimation of external exposure from beach sediments, it is assumed that the exposure is from a 15 cm thick sediment layer with homogeneous concentrations of each radionuclide. This assumption implies the build-up of radionuclides in the sediment layer with time.

The assumption of a sediment layer of 15 cm ensures that the external exposure is not underestimated. Any radionuclides at depths greater than 15 cm do not contribute to the external exposure due to the shielding effect of the overlying sediment layers. In summary, the approach applied in the REIA for estimating external exposures due to occupancy on beach sand is consistent with the approach used in IAEA SRS-19 [26].

The dose calculated for the first year of discharge is therefore representative of the highest committed effective dose that will occur over the discharge period. By taking this conservative approach, no assumption needs to be made of the actual period of discharge. The dose calculated is the committed effective dose from exposures in a year; it is compared to the dose constraint which is also expressed as the committed effective dose from exposures in one year.

The approach taken by TEPCO results in a highly conservative approach that is likely to overestimate the annual doses from both the consumption of seafood and external doses from marine sediments. Therefore, the IAEA notes that TEPCO has calculated the highest committed effective dose that would occur over the discharge period assuming that discharges will be reasonably similar every year and continuous.

The approach adopted is described in detail in the REIA [25].

As part of the discussions on accumulation of radionuclides in sediments, during the missions to TEPCO, the Task Force highlighted in-growth of radioactive progeny in the sediments in the REIA. An evaluation of the approach taken for the consideration of in-growth of progeny radionuclides by TEPCO is given in the text box below. In summary, the IAEA consider that the approach adopted in the assessment of doses of humans and biota in the REIA is appropriate. While this will not make any noticeable change in the overall committed effective doses given the radionuclides in the discharges and the exceedingly low levels of radionuclides in the seabed sediment, the Task Force have suggested that this could be described more clearly in the REIA in the future as part of its periodic review.

Behaviour of radioactive progeny radionuclides in the marine environment

Some radionuclides in the source term decay to radioactive progeny nuclides (see Section 3.3). The REIA does not consider the transfer of radioactive progeny nuclides in the environment. However, radioactive progeny nuclides, if generated, do not contribute in a relevant way to the exposure during the period of the discharge of ALPS treated water. This can be explained as follows:

- For any of the progeny radionuclides in the source term with half-lives much shorter than those of the parent radionuclide, such as ^{90}Sr , ^{106}Ru , ^{137}Cs , ^{144}Ce , the environmental transfer is not relevant because the progeny radionuclides decay rapidly. However, in the dose coefficient for estimating

the doses from a particular radionuclide, the contribution of short-lived progeny nuclide to the radiation dose is properly considered.

- For long-lived progeny radionuclides - such as ^{147}Pm , ^{234}U , ^{238}U , ^{237}Np , ^{238}Pu , ^{239}Pu , ^{240}Pu , ^{241}Pu , ^{241}Am , ^{244}Cm , the ingrowth of the progeny radionuclides into environmental compartments during the discharge period is negligible.
 - The dose coefficients for inhalation and ingestion of radionuclides are calculated to take account of the committed dose from intakes of radionuclides in a year integrated until the individual 70 years old. During this time, the ingrowth of radioactive decay products in the human body is considered.
 - For example, an adult is assumed to be age 20, for the purposes of calculating dose coefficients, at the time of intake and the dose coefficient takes into account the radiation dose to the body over a period of 50 years (i.e., to age 70).
-

TEPCO has used concentration factors in their assessment of transfer to marine foods in the aquatic environment which is a conservative approach. The concentration factors used are from international literature, in particular, data compiled by IAEA [29] This approach is similar to that used in IAEA [26]. and is commonly used to assess activity concentrations in marine foods from discharges of radionuclides to the environment. A specific activity⁵ model provides an alternative estimate under equilibrium for the long-lived nuclides ^{14}C and tritium in seafood. In the specific activity model, the release of the radionuclide is assumed to result in a constant ratio between the released isotope and the stable isotope of the element in the environment and the behaviour of the radionuclide in the environment is assumed to be the same as that of the stable isotope. The concentration factors used for ^{14}C and tritium in the REIA [15] are consistent with the concentrations predicted using a specific activity model.

Speciation of tritium in the environment

GSG-10 paragraph 5.9 states that the “....physical properties.....and chemical properties relevant for environmental transfers and dosimetry of radionuclides” should be selected.

For estimating the doses to the representative person from ingesting tritium, TEPCO initially assumed that all tritium is in the form of tritiated water (HTO). The Task Force advised that it is also important to include tritium in its organically bound form (OBT) with respect to consumption of food, even if the doses from tritium are not an important contributor to the overall dose. The Task Force further noted that this is likely to be a topic of interest to many interested parties and suggested that TEPCO better explains the uncertainties in OBT formation and the associated doses.

Following the discussions with the Task Force, TEPCO took account of a fraction of OBT (10%) in the environment based on ICRP 56. ICRP 56 [17] says that the exact proportions of OBT in the various molecular components of the human diet are unknown and there are uncertainties associated with the doses received following the intake of tritium. In order to address this uncertainty, and while recognizing that based on the results of the REIA the consideration of organically bound tritium in the estimates of doses is unlikely to impact the overall doses estimated, the Task Force highlighted that it is important that TEPCO demonstrates that it has considered the different chemical forms of tritium in the environment in the REIA. Following these discussions, TEPCO has included a more detailed discussion of how organically bound tritium is addressed in the REIA and has included the conservative assumption that 100% of the tritium in

⁵ The specific activity is defined as the activity per unit mass of the corresponding stable element.

consumed fish and seafood is in the form of organically bound tritium. This has not had an impact on the estimated doses to the public as explained further below when the results of the REIA are presented and discussed.

For protection of flora and fauna, the ICRP approach does not explicitly consider the dose from OBT. ICRP 148 [18] contains a review of data from studies of the relative biological effectiveness (RBE) of low-energy beta particle emissions from tritium. The review of experimental data showed no clear pattern of differences between tritium species and, for radiation protection purposes, it was considered reasonable on the basis of current knowledge that RBE weighted absorbed dose rates for RAPs should be calculated using values of 1 for all low-LET radiations for comparison with the relevant DCRL. A caveat is made in ICRP 148 [19] that, if exposures to tritium beta particles are within or close to the DCRL band, additional review and possible modification of RBE weighting might be warranted. The dose rates calculated for the marine RAPs in the REIA (see below) are orders of magnitude below the DCRLs, and so there is no need for additional specific considerations of OBT.

TEPCO considered the uncertainty in the concentration of OBT in fish and seafood in the REIA (Attachment III of the REIA). TEPCO has reported that in its monitoring of fish since 2014 around the Fukushima Daiichi Nuclear Power Station, OBT has never been observed in the 83 samples measured so far. TEPCO also refers to monitoring of the concentration ratio between HTO and OBT in the environment around the La Hague reprocessing plant in France which is the same for the seafood species measured, including fish and seaweed.

Additional information on tritium and how it behaves in the environment is provided in Annex 5.

Identification of Exposure Pathways

The next step in the REIA is the identification of exposure pathways and the choice of the representative person for whom the doses are estimated. The main transfer processes in the marine environment and exposure pathways for humans are illustrated in Figure 3.15.

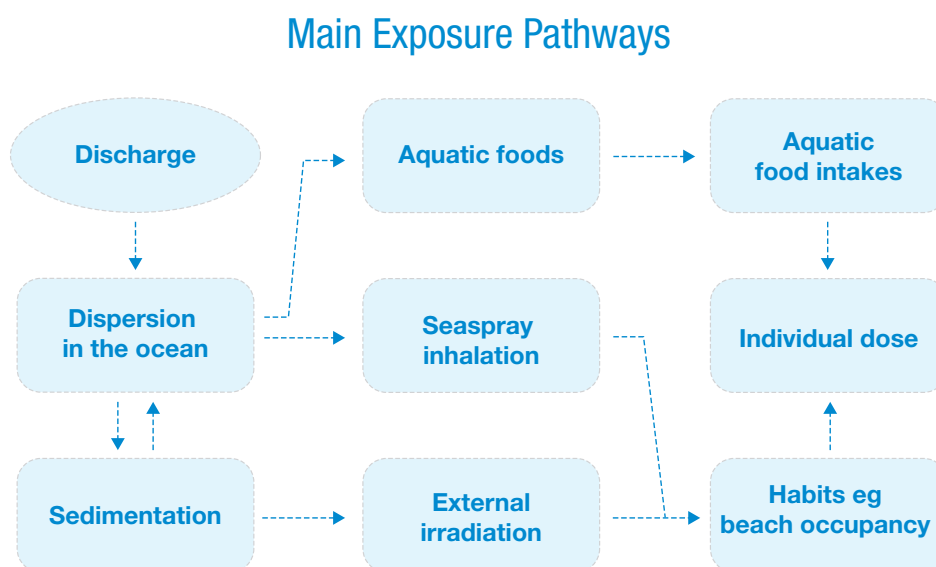

Fig. 3.15. Illustration of main transfer processes and exposure pathways for humans in the marine environment

In a REIA, the exposure pathways that are considered relevant for discharges to the environment for a particular scenario and the relative importance of different exposure pathways should be identified. In

the case of discharges to the sea, consideration needs to be given to the exposure pathways arising from uses of the seawater, such as production of aquatic foods, fishing industries and recreation (paragraph 5.27 of GSG-10 [11]). In paragraph 5.30 of GSG-10 [11], it is explained that, depending on the exposure scenarios and the site characteristics, not all the possible exposure pathways may need to be included in the assessment because the contribution of an exposure pathway to the overall dose depends on the radionuclides involved, the habit data, the time spent at a location and other characteristics of the population being considered. Therefore, some exposure pathways may be excluded from the assessment on the grounds that the doses associated with them are evaluated to be non-existent or negligible. However, paragraph 5.30 in GSG-10 [11] clarifies that the decision to exclude particular exposure pathways from consideration should be justified.

In the REIA presented by TEPCO, a number of internal and external exposure pathways were initially identified as relevant for the ALPS treated water discharges to the sea. During the first mission to TEPCO, the Task Force noted that although the dominant exposure pathway is expected to be ingestion of seafood, it is good practice to demonstrate in the REIA that all plausible exposure pathways have been considered, even if the doses are expected to be very low. This is necessary to justify excluding exposure pathways that make a minor contribution to the doses. The Task Force identified the minor exposure pathways of inhalation of resuspended materials (e.g., sea-spray, beach sediments), beta doses to the skin from handling fishing nets and inadvertent ingestion of sediments, that could be considered for completeness.

Following the discussions with the Task Force, TEPCO included other minor exposure pathways in accordance with GSG-10 [11] and considered other potential exposure pathways listed in other national or international guidelines. The list of exposure pathways considered in the REIA is given in Table 3.6. TEPCO has documented its assessment of the doses from the minor exposure pathways in the February 2023 version of the REIA for completeness; a presentation and discussion of the results is given later in this Section.

TABLE 3.6. EXPOSURE PATHWAYS CONSIDERED BY TEPCO IN THE REIA (major exposure pathways in bold)

External exposure pathways	Internal exposure pathways
External exposure received from: <ul style="list-style-type: none"> • Sea surface • Hull of ship • Immersion in water (swimming) • Beach sediments • Fishing nets 	Ingestion of seafood (fish, molluscs and seaweed) Inadvertent ingestion of seawater while swimming Inhalation of sea spray

Assessment of the dose to the Representative Person

Having identified the pathways by which a person can be exposed to radionuclides in the environment following the discharges to sea, the next step in the REIA is to assess the doses to the representative person. The representative person is selected to have the characteristics of individuals who are likely to be more highly exposed.

An important characteristic when assessing doses to the representative person is the assumed location of the representative person (e.g., his or her distance and direction from the point of discharge of radionuclides) as described in paragraph 5.34 of GSG-10 [11]. The location where the representative person lives can be based on an actual person or a group of persons, or on a postulated person or group of persons living at a location selected using cautious assumptions (e.g., at a point where the highest concentrations in the area can be expected).

TEPCO stated in the REIA report that the characteristics of the representative person were set in accordance with “Public dose assessment guideline for safety review of nuclear power light water reactor”. Habit data, such as consumption rates of food for the representative person, used in the assessment were based on national statistical datasets (National Health and Nutrition Survey in Japan). Table 3.7 summarizes the characteristics of the representative person as described by TEPCO in the REIA report. TEPCO considered the habits of three age groups; adults, children and infants in the assessment of doses in the REIA.

TABLE 3.7. HABIT DATA USED IN THE REIA [17] BY TEPCO FOR THE REPRESENTATIVE PERSON

Parameter	Adult	Child	Infant
Ingestion rates [g d⁻¹]^a			
Fish	58(190) ^b	29(97)	12(39)
Invertebrate	10(62)	5.1(31)	2(12)
Seaweed	11(52)	5.3(26)	2.1(10)
Occupancies for the representative person [hr y⁻¹]			
Beach	500		
Fishing	2880		
Handling fishing nets	1920		
Swimming	96		

^a Ingestion rates of seafood for the representative person are based on national statistical datasets for Japan.

^b Two scenarios were considered in the assessment: one for a person who ingests seafood at the average values and the other for a person who ingests a large amount of seafood (mean + 2σ).

For estimating doses to the representative person from all the exposure pathways considered, TEPCO used the marine dispersion model to calculate activity concentrations in sea water in a 10 km x 10 km area around the discharge point (see Fig. 3.16). These activity concentrations in seawater were used as the basis for all the doses calculated for the representative person. The Task Force discussed with TEPCO whether the average concentration used is conservative given the higher concentrations in the sea predicted using the marine dispersion model along the coast due to the sea currents both within the ‘difficult to return zone’ and just outside it. These higher concentrations in the sea were taken into consideration in the further iterations of the REIA with respect to identifying in more detail the characteristics and location of the representative person. In particular, the Task Force discussed with TEPCO that no account was being taken of members of the public using local beaches for recreational purposes. TEPCO explained that this was a conservative assumption as members of the public cannot live or undertake activities close to the coastline within the ‘difficult to return zone’ or the ‘no claim for fishing zone’; however TEPCO also recognized that whilst there are currently no inhabitants 3km north of the site, the representative person could travel to the beach. TEPCO subsequently used this location (3km north of the site) to calculate external doses in the revised versions of the REIA (see Fig. 3.16). Additionally, TEPCO recognized that individuals could also catch a small proportion of their fish and seafood consumption from local beaches at some point in the future and included a scoping calculation in the REIA to include this. The calculation indicated that the dose to an adult from ingestion of fish and seafood could increase by about 20% if 10% of their consumption was caught locally.

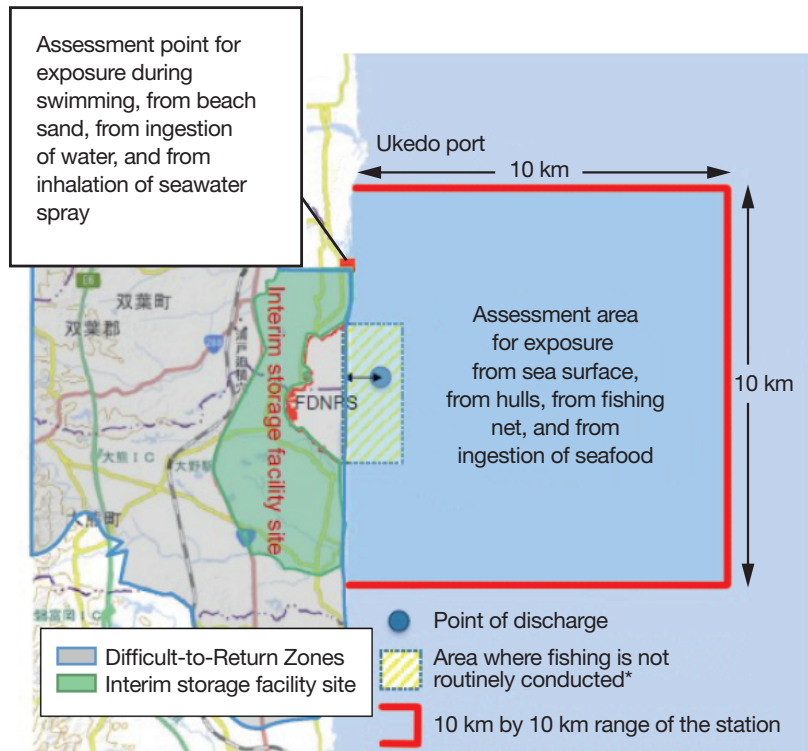

Fig 3.16. Location of the representative person for normal operation of discharge of ALPS treated water in the REIA (taken from TEPCO [15])

Paragraph 5.36 of GSG-10 [11] explains that the individual effective dose to the representative person is the sum of the committed effective dose from intakes of radionuclides (i.e., from internal exposure by ingestion and inhalation) and the effective dose from external exposure. Doses from internal exposure are calculated using dose coefficients from intakes of radionuclides by ingestion and inhalation, which provide the committed effective dose per unit activity of intake, expressed in units of sieverts per becquerel (Sv/Bq). Tabulated values of dose coefficients applicable for members of the public are available in GSR Part 3 [8]. Standard models exist to calculate the effective dose from external exposure, as well as compilations of dose coefficients.

The committed effective dose (calculated for the representative person) is an annual dose. This annual dose is compared with the dose constraint of 0.05 mSv per year. As discussed above, the annual committed effective dose calculated in the REIA, is the highest annual dose that could be expected over the period of the discharges. Assuming that this dose is received annually over the period of the discharges is therefore a conservative assessment.

Assessment of doses to flora and fauna and endpoints

The generic methodology for assessing exposure of flora and fauna based on the ICRP approach in GSG-10 [11] uses representative organisms selected directly from the ICRP reference animals and plants [12; 13]. These representative organisms are selected to be those relevant for the specific major ecosystem (e.g., terrestrial, marine, freshwater) assumed to be located in the area where the exposure conditions lead to the highest doses.

The ICRP approach uses the concept of reference plants and animals [12]. The ICRP defines three species to be used as references for the protection of the marine environment. The conceptual approach is that,

if the criteria for those three reference species is not exceeded, then all the species can be assumed to be equally well protected, at the level of their populations (particularly for planned exposure situation). The three species were identified based on their wide global distribution and the existence of actual data on the effects of very low increments of radiation doses (increments comparable with the variation of natural radiation in different scenarios). TEPCO has calculated dose rates for the three reference marine species in ICRP, namely flat fish, crab and brown seaweed. Figure 3.17 shows the exposure pathways and the calculation undertaken to calculate dose rates (mGy per day for the 3 representative marine organisms).

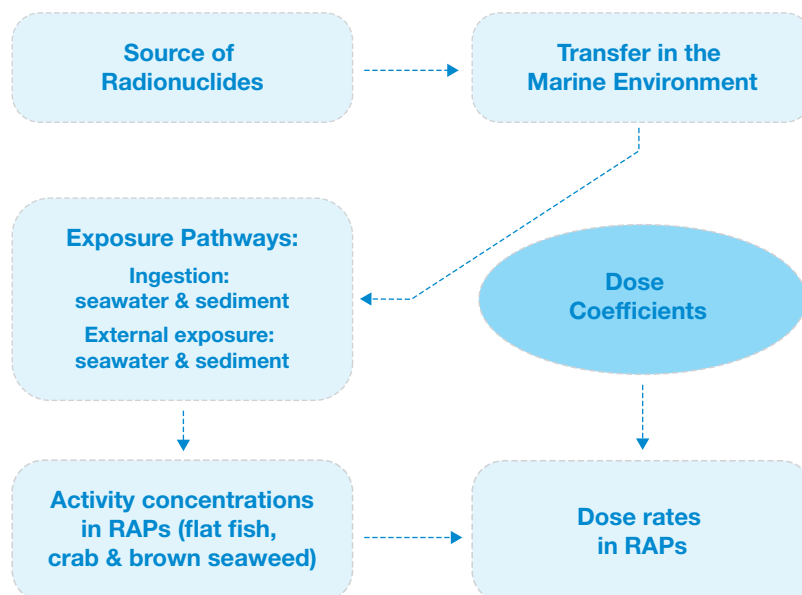

Figure 3.17. Exposure pathways and assessment of dose (mGy/day) rates to flora and fauna in the REIA

The exposure pathways considered, in line with the approach described in GSG-10 were:

- Internal exposure from radioactive materials ingested by animals or absorbed by plants
- External exposure from the surrounding seawater
- External exposure from the surrounding seabed sediments

Results of the REIA

TEPCO has presented the annual committed effective doses calculated in the REIA to the representative person for the different exposure pathways and different age groups considered. The age groups and dose coefficients used for calculating committed effective doses for adults, children, and infants were in accordance with those provided in GSR Part 3 [8].

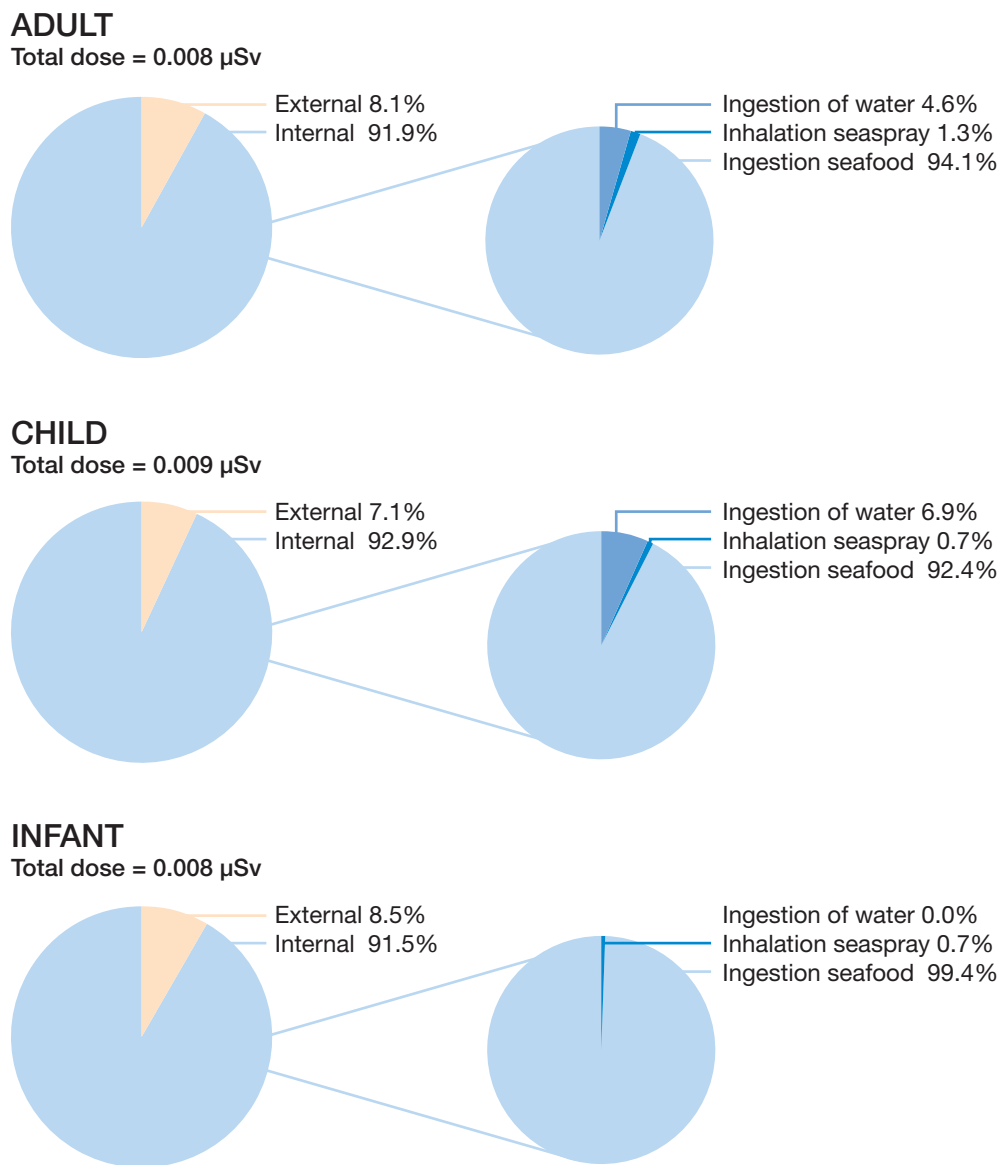

Figure 3.18: Contribution of exposure pathway to the committed effective dose for high seafood consumers as a function of age group (K4 ALPS treated water tank group)

Figure 3.18 shows the contribution of exposure pathways to the committed effective dose for high seafood consumers as a function of age group. The Figure shows that the contribution from internal exposure contributes about 90% of the total dose for all age groups and that the ingestion of seafood contributes between 92% and 99% of the internal dose. Figure 3.19 presents information for the committed effective doses calculated as a function of age and main exposure pathways based on the source term for the K4 ALPS treated water tank group. The results for the other two tank groups considered are very similar.

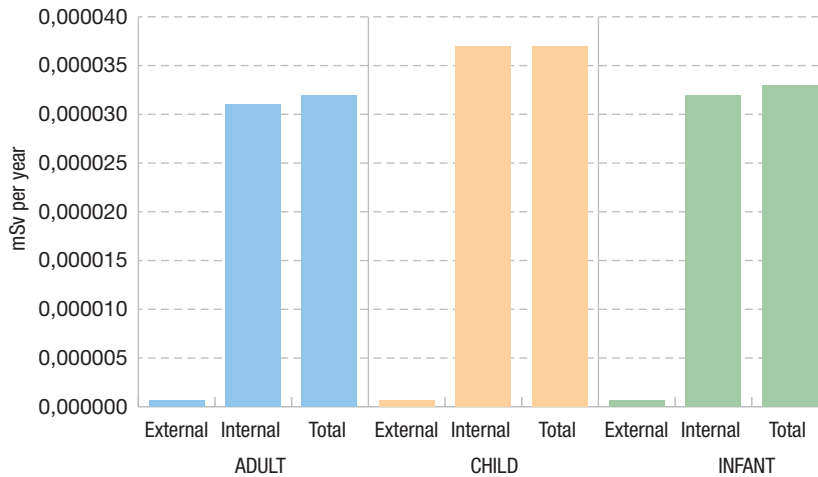

Figure 3.19: Committed effective dose as a function of age and exposure pathway (K4 ALPS treated water tank group)

Table 3.8 also shows that the annual committed effective dose is similar across the three ALPS treated water tank group source terms for adults. Table 3.8 shows that the relative contributions of the radionuclides to the ingestion dose varies between the three source terms but in all cases the doses are very low and more than 1000 times lower than the dose constraint of 0.05 mSv per year. Carbon-14, ¹²⁹I and ⁵⁵Fe are the largest contributors to the internal dose and the total dose. This is also the case for children and infants. Tritium typically contributes no more than a few percent of the total committed effective dose. The highest contribution from tritium is from the inadvertent ingestion of seawater while swimming (adults and children); it is noted that TEPCO assumes a conservative consumption rate of 0.2 l/h of sea water while swimming.

Age group	Seafood intake	Storage tank	Dose (mSv/y)	Storage tank	Dose (mSv/y)	Storage tank	Dose (mSv/y)
		K4		J1-C		J1-G	
Adults	High	¹²⁹ I	1.8E-05	¹²⁹ I	2.0E-06	¹⁴ C	4.4E-06
		¹⁴ C	7.1E-06	¹⁴ C	1.6E-06	⁵⁵ F	2.5E-06
		⁵⁵ F	3.8E-06	⁵⁵ F	8.5E-07	¹²⁹ I	1.6E-06
		⁷⁹ Se	1.6E-06	³ H	5.0E-07	⁷⁹ Se	9.5E-07
		⁶⁰ Co	5.8E-07	⁷⁹ Se	3.2E-07	³ H	5.0E-07
		³ H	5.0E-07	⁶⁰ Co	1.2E-07	²⁴⁰ Pu	3.0E-07
		¹³⁷ Cs	1.8E-07	²⁴⁰ Pu	1.2E-07	²³⁹ Pu	3.0E-07
		⁹⁹ Tc	1.1E-07	²³⁹ Pu	1.2E-07	²⁴¹ Am	2.8E-07
		¹²⁵ Sb	2.8E-08	²⁴¹ Am	1.1E-07	²³⁸ Pu	2.7E-07
		¹⁵⁵ Eu	2.7E-08	²³⁸ Pu	1.1E-07	⁶⁰ Co	2.6E-07
		All others	1.2E-07	All others	3.6E-07	All others	8.9E-07
		Total	3.2E-05	Total	6.2E-06	Total	1.2E-05

Table 3.8. Annual committed effective dose for an adult high seafood consumers as a function of radionuclide and ALPS treated water tank group

As discussed above, the ingestion of seafood is the highest contribution to the committed effective dose for all age groups and for the three ALPS treated water source terms considered in the REIA. Figure 3.20 shows the relative contributions of radionuclides to the ingestion dose for all three age groups for a high seafood consumer. The Figure shows that the radionuclides contributing most to the ingestion dose are ^{129}I , ^{14}C , ^{55}Fe and ^{79}Se which contribute over 90% of the dose. Fe-55 and ^{79}Se are relatively more important for children and infants due to the higher dose coefficients (Sv per Bq of intake). It is noted that TEPCO has not detected ^{55}Fe and ^{79}Se in the ALPS treated water and the estimated committed effective doses are based on levels of these radionuclides in the discharge being at the detection limits for the analytical technique used. It is not expected that these radionuclides will be detected in the environment and in seafood but they are included in the CRMP (see Section 3.5). However, it should be stressed that the annual committed effective ingestion dose is still very low for all age groups, and less than $0.04 \mu\text{Sv}$ per year.

Total adult ingestion dose = $0.03 \mu\text{Sv}$

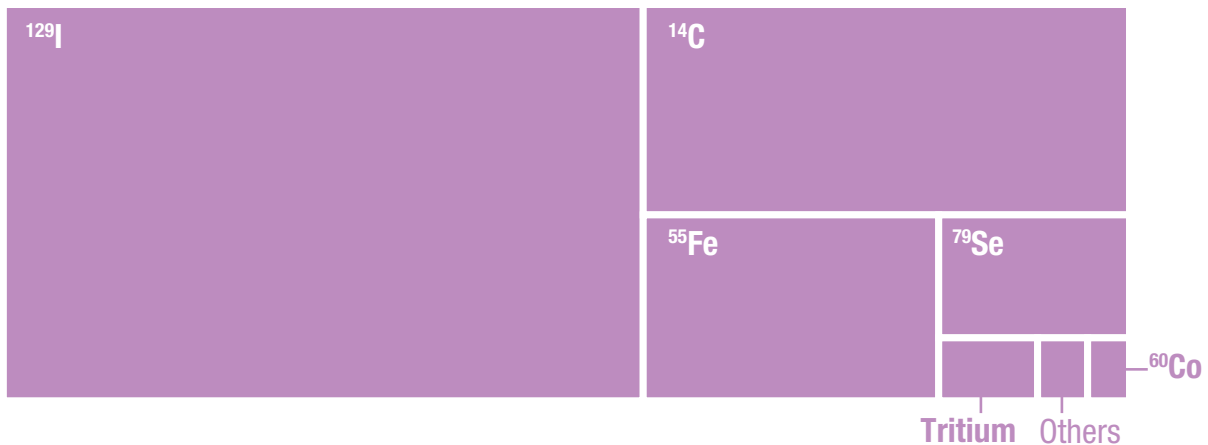

Total Child Ingestion dose = $0.04 \mu\text{Sv}$

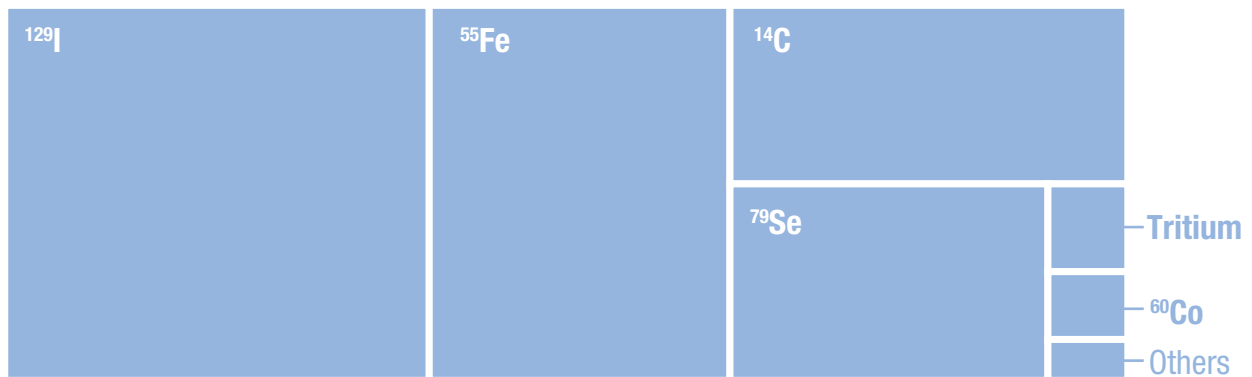

Total Infant Ingestion Dose = $0.03 \mu\text{Sv}$

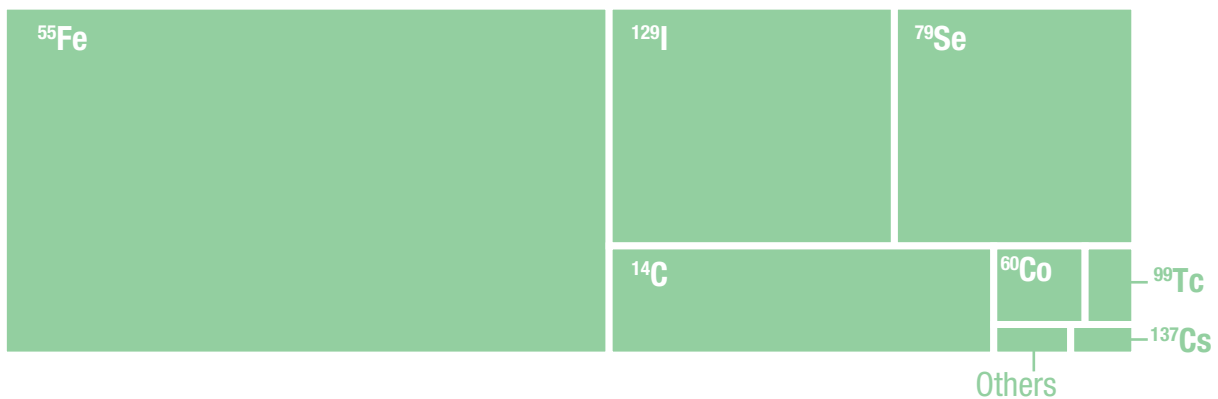

Figure 3.20. Committed effective dose from ingestion for high seafood consumer as a function of age group: percentage contribution of radionuclides (K4 tank group)

Figure 3.21 shows the radionuclide contribution to the annual external dose for the representative person. The external dose is the sum over all the external exposure pathways considered in the REIA but is dominated by the exposure to occupancy on the beach (about 85% for the radionuclides contributing most to the external dose). The external dose is only calculated for an adult, as it is assumed that children only spend time on the beach when accompanied by adults and that there is no significant difference in the effective external dose received by the different age groups. Figure 3.21 shows that the two radionuclides contributing most to the effective external dose are ^{60}Co and ^{137}Cs .

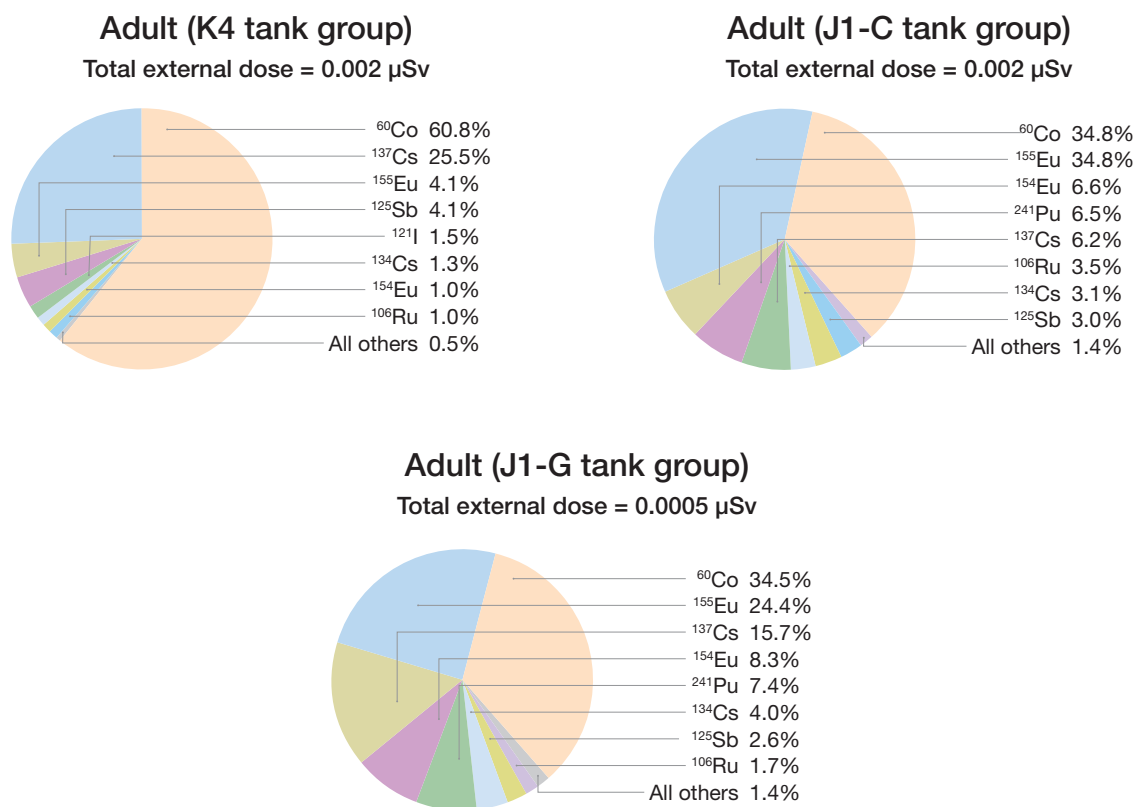

Figure 3.21. Effective external dose as a function of radionuclide and ALPS treated water tank group (the external dose is assumed to be the same for all age groups in the REIA)

The doses to members of the public estimated in the REIA as a result of discharges of ALPS treated water are more than 1000 times lower than the dose constraint set by NRA of 0.05 mSv/y. Subsequently, using the approach of a generic methodology in conjunction with site-specific habit data is in line with the guidance in GSG-10 [11] and there is no need to refine the dose assessment with more complex models and site-specific parameter values on radiological protection grounds. However, to address the international interest in the radiological impact of the proposed discharges, in the REIA undertaken by TEPCO, a site-specific marine dispersion model and a full range of exposure pathways has already been considered.

The REIA also contains an assessment of doses to flora and fauna using the approach given in GSG-10 [11], which is in-line with the ICRP approach [12;13]. The highest dose rates to flora and fauna over the period of discharges of ALPS treated water are estimated by TEPCO to be $< 1 \cdot 10^{-6}$ mGy per day (0.000001 mGy per day). The calculated dose rates to the three reference organisms (flat fish, crabs and seaweed) are more than a million times lower than the lowest derived consideration reference level (DCRL) of 1 mGy per day, which is for flat fish.

Transboundary impacts of the ALPS treated water discharge

In paragraph 5.24 of GSG-9 [9] it is identified that if a discharge could cause significant public exposure outside the territory or other area under the jurisdiction or control of the State in which the discharge takes place, the operating organization should make an assessment of the radiological impacts of the discharges on the public and the environment in these areas.

The Task Force discussed with TEPCO that there are radionuclides in the source term that could have an impact for global circulation in the oceans (e.g., ^{129}I , ^{14}C , ^{99}Tc , ^3H) and that, even though doses from global dispersion and circulation in the oceans are likely to be very small, or effectively zero, doses to neighbouring countries from global circulation are of interest to the international community. Therefore, this topic should be considered and explained in the REIA. TEPCO noted that the flow of sea currents was taken into account within the model and the estimated activity concentrations of tritium in the ocean were low and, that it would be difficult, or impossible, to detect tritium from the ALPS treated water at large distances from the point of discharge.

The Task Force noted that the calculational area of simulations for the marine dispersion model is 490 km north-south and 270 km east-west and had encouraged TEPCO to use longer distance dispersion calculations to show clearly that doses to neighbouring countries are negligible. TEPCO explained that based on meteorological and oceanographic conditions over a 7-year period from 2014 to 2020, the marine dispersion model predicts very low concentrations of tritium that will be undetectable at the boundary of the simulation area (490 km north-south and 270 km east-west of the FDNPS); therefore, extending the range of the existing model boundary would not add any technical value for assessment of the radiological impact of the ALPS treated water discharges. The Task Force accepted TEPCO's reasoning that concentrations of tritium beyond this area will be even lower and therefore there is no scientific justification for redoing the calculations for a larger area. The Task Force recommended that including estimates of activity concentrations of ^{14}C and ^{129}I in seawater at the boundary of the simulation area could also demonstrate that the concentrations of these radionuclides are negligible and that this would provide a useful comparison for communication with interested parties. TEPCO added this into the revised REIA in response to the Task Forces' views. TEPCO also stated in the REIA that the yearly radioactive discharge of ^{14}C and ^{129}I from ALPS treated water is a very small amount, therefore its impact at global scale is negligible.

Based on the results of the marine dispersion model used by TEPCO, activity concentrations in international waters will not be influenced by the discharge of ALPS treated water into the sea and the transboundary impacts are therefore negligible. However, the baseline environmental monitoring in place around the FDNPS and in the surrounding area of the Pacific Ocean, as well as that planned by TEPCO and the Government of Japan after the start of discharges (see Section 3.5) is extremely important to ascertain any levels of radionuclides in the sea due to the discharge of ALPS treated water and to verify the findings of the REIA.

TEPCO stated in the REIA that the yearly radioactive discharge of ^{14}C and ^{129}I from ALPS treated water is a very small amount, therefore its impact at global scale is negligible.

TEPCO predictions of activity concentrations of tritium in the Pacific Ocean

In the REIA submitted by TEPCO, the estimated activity concentrations in the ocean based on the marine dispersion model show that:

- Estimated tritium concentrations of sea water above 1 Bq/L is limited to an area of up to 3 km around FDNPS.
- The estimated average tritium concentrations for the area 10 km x 10 km for all water layers is 0.056 Bq/L and 0.12 Bq/L for the surface layer. For estimating exposures due to occupancy on the beach and from inhalation of sea spray, the underlying tritium activity concentration in water is 0.88 Bq/L.

The simulated tritium activity concentration at the eastern boundary of the simulation area is between 0.0001 and 0.0003 Bq/L. For comparison, the average H-3 concentration in the North Pacific Ocean between latitudes 30 N and 45 N is about 0.04 Bq/L¹ and background activity concentrations in the sea around the FDNPS are in the range of 0.1 – 1.0 Bq/l. This means that the tritium concentration in the sea from the discharge of ALPS treated water at the boundary of Japanese territorial waters will already be lower than the background concentration of tritium in the North Pacific between latitudes 30 N and 45 N.

1. Oms, P.E., Bailly Du Bois, P., Dumas, F., Lazure, P., Morillon, M., Voiseux, C., Le Corre, C., Cossonnet, C., Solier, I., Morin, P.: Inventory and distribution of tritium in the oceans in 2016. *Science of the Total Environment*, Elsevier, 2019, 656, pp. 1289-1303. 10.1016/j.scitotenv.2018.11.448. hal-02336283

Assessment of doses from potential exposures

As part of the safety assessment for facilities and activities, various types of accident are postulated to identify engineered safety features and operational actions to reduce their likelihood and, if an accident does occur, to mitigate its consequences (paragraph 5.44 of GSG-10 [11]). In accordance with the recommendations provided in GSG-10 [11], a prospective assessment of potential exposures to members of the public should be performed for exposure scenarios resulting from postulated accidents identified on the basis of the safety assessment. The representative person for potential exposures needs to be identified, noting that the representative person may not be the same as that selected for normal operations, and an assessment of the dose to the representative person estimated and compared with the applicable established dose criteria.

TEPCO has included in the REIA [15] an assessment of the potential doses to a representative person from two identified accident scenarios affecting the discharge of ALPS treated water. These are:

Case 1 – Leakage from piping

In this scenario, TEPCO assumed that a leakage from a pipe occurred that caused undiluted, treated water, to flow directly into the sea. While countermeasures are in place to detect an incident of this nature within 24 hours or less, it is assumed that this scenario continued undetected over 20 days resulting in the loss of an entire tank group (10 tanks in total), or around 10,000 m³ of treated water.

Case 2 – Leakage from tanks

In this scenario, TEPCO assumed a worst-case accident where there was a catastrophic and immediate rupture of all tanks in the measurement and confirmation facility which resulted in all of the treated water being discharged directly into the sea without any further dilution. This worst-case scenario would result in all three tank groups (30 tanks in total), around 30,000 m³ of treated water, being directly discharged into the sea without dilution.

TEPCO has used a dose criterion of 5 mSv/year in line with the recommendations in GSG-10 [11].

The Task Force discussed the assumptions made by TEPCO in its initial calculation of the impact of these potential exposure scenarios. It was agreed that it is important to calculate the doses from all exposure pathways and to the three age groups considered in the REIA (adults, children and infants),

without consideration of protective measures or mitigation measures that could be implemented if such an accident occurred. In particular, the Task Force emphasized that the REIA needs to include marine food consumption, even if it is expected that marine products in the restricted zone would in practice be banned, and all radionuclides in the potential source term need to be considered or represented in the relevant calculations.

TEPCO stated that the representative person for the potential exposure assessment is an adult fisherman who consumes a large amount of seafood; the location used for all exposure pathways is from 3 km north of the site. In addition, potential doses from internal exposure pathways for children and infants have been calculated (inhalation of sea spray, ingestion of seafood and inadvertent ingestion of water (children only)). The exposure times assumed for the adult fisherman (representative person) is given in Table 3.9.

Table 3.9. Exposure times used for the representative person for the assessment of potential exposures (taken from REIA)

Item	Case 1 (27 days)	Case 2 (8 days)
Operation hours on a ship	210 hours	63 hours
Swimming time	7.1 hours	2.1 hours
Coastline stay time	37 hours	11 hours
Operation hours near fishing nets	140 hours	42 hours
Ingestion of seafood	Ingestion of persons who consume a large amount of seafood in 27 days	Ingestion of person who consume a large amount of seafood in 8 days

For potential exposures, GSG-10 [11] states that the effective dose resulting from the sum of the committed effective dose from internal exposure pathways and the effective dose from external exposure should be calculated. However, it also states that the equivalent dose to certain organs (e.g., thyroid) can be considered; the Task Force suggested that TEPCO could clarify that it had considered equivalent doses in the REIA. TEPCO explained that, although a higher concentration of radionuclides would be released in the event of an accident, the radionuclides are the same and the behaviour in the environment and exposure pathways are the same. TEPCO stated that the predicted effective doses are very low, including the highest dose from ¹²⁹I (approx. 0.01 mSv for Case 2) and that the assessment of equivalent dose (e.g., to the thyroid for infants) is not needed at these very low levels of effective dose.

The range of potential committed effective doses calculated for the representative person for Case 1 (piping rupture) considering the three tank groups (K4, J1-C and J1-G) is 0.0002 - 0.0003 mSv. For Case 2 (tank damage) the range of potential committed effective doses is 0.008 - 0.01 mSv. The only significant exposure pathway for all age groups is the ingestion of seafood which contributes more than 99% of the committed effective dose. The doses for children and infants are slightly higher than those for adults but for both accident cases are less than 0.02 mSv.

Consideration of Uncertainties and Sensitivity analysis

In Chapter 8 of the REIA, various sources of uncertainties are considered and the possible impact on the results is estimated. TEPCO has considered the following items in the REIA as part of their assessment of uncertainties. Details of the uncertainty, as described by TEPCO, are given in parentheses.

- Selection of the source terms (The composition of radionuclides of ALPS treated water is unknown until secondary treatment and measurement is completed. There is uncertainty associated with the measured values).

- Modelling of diffusion and transfer in the environment. (The meteorological and oceanographic data has annual variations. There is uncertainty associated with the diffusion simulation model).
- Migration of radionuclides from sea water to beach sediments. (The migration factor from water to beach sediments for the calculation of external dose is not element dependent, so there is uncertainty associated with the dose conversion factor).
- Transfer of radionuclides from sea water to aquatic foods. (The concentration factor for fish is uncertain, particularly for some elements, due to insufficient data).
- Selection of exposure pathways. (There are uncertainties associated with not necessarily having covered all possible exposure pathways).
- Selection of the representative person. (The area around the FDNPS is undergoing reconstruction, so habit data from before the accident have been used. As a result, there are uncertainties due to the actual habits at the current time not being known in detail. There is uncertainty associated with the sea area chosen as being representative of where seafood consumed by the representative person is caught).

In each case, details of the assessment and the calculations carried out to show the sensitivity of the results of the REIA are given. Taking account of uncertainties, the estimated doses to the representative person due to the discharges of ALPS-treated water will be far below the dose constraint.

Regulatory Review of the REIA

As described in Section 3.1, prior to approval of the Implementation Plan and the authorization of discharges, NRA reviews the Implementation Plan, including the REIA and documents its findings in the ‘Review Results Document’. The draft results of its review of the REIA are discussed with TEPCO in public meetings. The Task Force was informed at both NRA missions that during the review meetings with TEPCO, a number of topics had been discussed with TEPCO that required changes and updates to be made to the REIA and that it had been an iterative process. NRA also publishes its draft Review Results Document for 30 days of public review and comment as part of the process. An overview of the major milestones in this process is included in Annex 3.

The NRA presented to the Task Force the main points raised in the discussions with TEPCO and their requests for clarifications and further work on the REIA. The Task Force noted that the international safety standards state that the regulatory body ‘should agree that the methodology adopted is adequate for its proposed purpose’ in discussion with the applicant (GSG-9), which NRA has done.

NRA explained that it had undertaken an independent verification of TEPCO’s marine dispersion model and they presented the results to the Task Force. NRA also presented details and updates regarding its ongoing (at the time of the mission held in January 2023) review of the November 2022 version of the Implementation Plan and REIA. The Task Force specifically noted that NRA has reviewed TEPCO’s approach for calculating activity concentrations in the aquatic environment which is an important topic raised by the Task Force and other interested parties.

3.4.3 Conclusions

The IAEA has concluded that the approach taken by TEPCO and the NRA is consistent with the relevant international safety standards included under this section of the report. Further detailed findings are included below:

- A REIA has been produced and is compliant with the international safety standards. The REIA follows the assessment approach given in IAEA GSG-10 [11] for protection of the public in

normal operations. The resulting doses are at least a factor of 1000 lower than the dose constraint of 0.05 mSv per year.

- For the assessment of the radiological impact of accumulation of radionuclides in seabed sediments, relatively simple models are applied in the REIA. However, the approach taken ensures that the resulting annual doses over the period of the planned discharge are not underestimated.
- The REIA contains an assessment of doses to flora and fauna using the approach given in GSG-10, which is in-line with the ICRP approach [12;13]. The estimated dose rates to the three marine representative animals and plants considered (flatfish, crab and seaweed) are more than 1 million times lower than the derived consideration reference levels set by ICRP.
- In the REIA, TEPCO has included an assessment of the potential doses to a representative person from two identified scenarios resulting in the unintended discharge of ALPS treated water. Considering all ages and tank groups the resulting potential doses are more than a factor of 100 lower than the recommended criterion set by NRA of 5mSv.
- The REIA includes the sensitivity of the doses estimated to the representative person and to reference animals and plants for relevant assumptions made by TEPCO. Taking account of uncertainties, the annual doses to the representative person (adult, children and infants) will be far below the dose constraint of 0.05 μ mSv per year.
- NRA has an iterative process for reviewing the REIA with TEPCO. The review process includes opportunity for the public to comment.

3.5. Source and Environmental Monitoring

3.5.1 Background

There are two general types of monitoring that are appropriate in the context of controlling discharges and the related public exposure. As noted in GSG-9 [9], paragraph 5.75, these are:

- a) Monitoring of the source, which involves measuring activity concentrations or dose rates at the discharge point.
- b) Monitoring of the environment, which involves the measurement of radionuclide concentrations in environmental media (including foodstuff and drinking water) and of doses or dose rates due to sources in the environment.”

Requirement 14 of GSR Part 3 [8] on monitoring for verification of compliance states that “Registrants and licensees and employers shall conduct monitoring to verify compliance with the requirements for protection and safety.”

In addition, Paragraph 3.54 of GSG-8 [10] states that “Such monitoring should provide sufficient information to determine whether the levels of public exposures comply with the dose limits and to demonstrate that protection and safety is optimized.”

Paragraph 3.37 of GSR Part 3 [8] states: “The regulatory body shall establish requirements that monitoring and measurements be performed to verify compliance with the requirements for protection and safety. The regulatory body shall be responsible for review and approval of the monitoring and measurement programmes of registrants and licensees.”

In accordance with paragraph 3.38 of GSR Part 3 [8], all monitoring activities are required to adhere to established criteria for quality assurance covering, inter alia, the design and implementation of the monitoring programmes, including properly maintained and calibrated equipment, sampling locations, suitably qualified and trained personnel and documented procedures.

In accordance with paragraph 3.137 of GSR Part 3 [8], the licensee is required to do the following:

- Establish and implement monitoring programmes to ensure that public exposure due to the discharges is adequately assessed and that the assessment is sufficient to verify and demonstrate compliance with the authorization;
- Maintain appropriate records of the results of the monitoring programmes;
- Report or make available to the regulatory body the results of the monitoring programme at approved intervals;
- Report promptly to the regulatory body any levels exceeding the operational limits and conditions relating to public exposure, including authorized limits on discharges, in accordance with reporting criteria established by the regulatory body;
- Report promptly to the regulatory body any significant increase in dose rate or concentrations of radionuclides in the environment that could be attributed to the discharges, in accordance with reporting criteria established by the regulatory body;
- Establish and maintain a capability to conduct monitoring in an emergency in the event of unexpected increases in radiation levels or in concentrations of radionuclides in the environment due to an accident or other unusual event attributed to the discharges;
- Verify the adequacy of the assumptions made for the assessment of public exposure and the assessment for radiological environmental impacts.

In accordance with GSG-9 [9], it is recommended to determine the requirements for monitoring, including frequency, by the assessed level of risk of radiological impact. With regard to environmental monitoring, GSG-9 [9] provides recommendations on conducting a preoperational analysis (before the discharges start) to determine the existing levels of background radiation in the environment surrounding the facility prior to the first discharge and to establish a baseline. In accordance with RS-G-1.8 [16], more frequent and detailed environmental measurements may be needed in the early stages of operation and all monitoring programmes are recommended to be subject to periodic review to ensure that measurements continue to be relevant for their purposes.

The regulatory body places requirements on the operator for the frequency for reporting of results and the form and required content of the reports. Paragraph 5.76 of GSG-9 [9] states that “The requirements for source monitoring and environmental monitoring should be specified in the authorization for discharges by the regulatory body. The necessity for and frequency of monitoring should be determined by the assessed level of risk of radiological impact.” The regulatory body is also responsible for review and approval of monitoring programmes, for ensuring their proper implementation and for recording and making available the results. The regulatory body also needs to periodically perform an independent review of the licensees’ or registrants’ source (and environmental) monitoring programmes and make provision for independent monitoring.

Paragraph 5.74 of GSG-9 [9] states that “The operating organization should make available, on request, results from source monitoring. This request may be incorporated within the operational limits and conditions of the authorization or specified in other regulatory documents.”

Paragraphs 5.84–5.85 of GSG-9 [9] provide recommendations for independent monitoring to the regulatory body. Paragraph 5.85 states that;

“The purpose of such independent monitoring may be one or more of the following:

- a) To verify the quality of the results provided by the operating organization;
- b) To verify the assessment of doses to the representative person”

Paragraph 5.6 of RS-G-1.8 [16] states that ‘One of the main goals of the monitoring programme is to check the assumptions and validate the results of the safety assessment. Thus, the monitoring programme should pay particular attention to the critical [exposure] pathways and critical radionuclides.’”

3.5.2 Review and Assessment

Source monitoring

TEPCO’s approach for source monitoring is based on sampling and laboratory measurements of activity concentrations in the sample (‘batch discharges’) and subsequent confirmation that the results demonstrate compliance with the authorized discharge limits. This is in line with Safety Guide RS-G-1.8 para 5.18 [16] which states: “In the case of batch discharges, the material for discharge is adequately characterized by the volume of the batch and the radionuclide composition of a sample taken at the reservoir from the homogenized batch prior to discharge”.

Discharge methodology

TEPCO has provided details of its discharge methodology, the discharge facility that it has constructed at FDNPS and its source monitoring plan in its Implementation Plan and the REIA contained therein. Prior to a given discharge occurring, ALPS treated water will be transferred from individual tanks at the FDNPS site into the measurement and confirmation facilities. The measurement and confirmation facility is shown within the context of the broader ALPS processing, storage and discharge facilities in Figure 3.20. The measurement and confirmation facilities are comprised of three groups of tanks, with each tank group containing 10 interconnected tanks. If needed the water will be first treated again using a secondary ALPS treatment, before being transferred to the measurement and confirmation facilities.

Circulation and agitation will be applied in each tank group to ensure homogeneity of the ALPS treated water prior to collecting representative samples and performing confirmatory measurements to ensure that the sum of ratios of the legally required activity concentrations of radionuclides other than tritium is less than one (see Section 3.3). The total volume of ALPS treated water contained in a single tank group can be regarded as a ‘batch’ (according to RS-G-1.8 para 5.18). The total radionuclide content of all batches discharged per annum defines the source which is compared to authorized limits on discharges (in Bq per year).

The proposed methodology for measurement and confirmation that each batch of ALPS treated water complies with the regulatory concentration limits prior to discharge can be summarized (for each group of 10 tanks in the measurement and confirmation facility) as follows:

1. An empty tank group in the measurement and confirmation facility is filled.
2. Homogeneity is achieved through agitation (intra-tank) and circulation (inter-tank) [20].
3. A single sample is taken for confirmatory analyses for all 30 radionuclides in the ALPS source term.
4. If the data indicates compliance with the discharge authorization, valves are opened to allow the ALPS treated water to be transferred for dilution and discharge.

Samples collected from the measurement and confirmation facility are the focus of the IAEA’s corroboration of source monitoring.

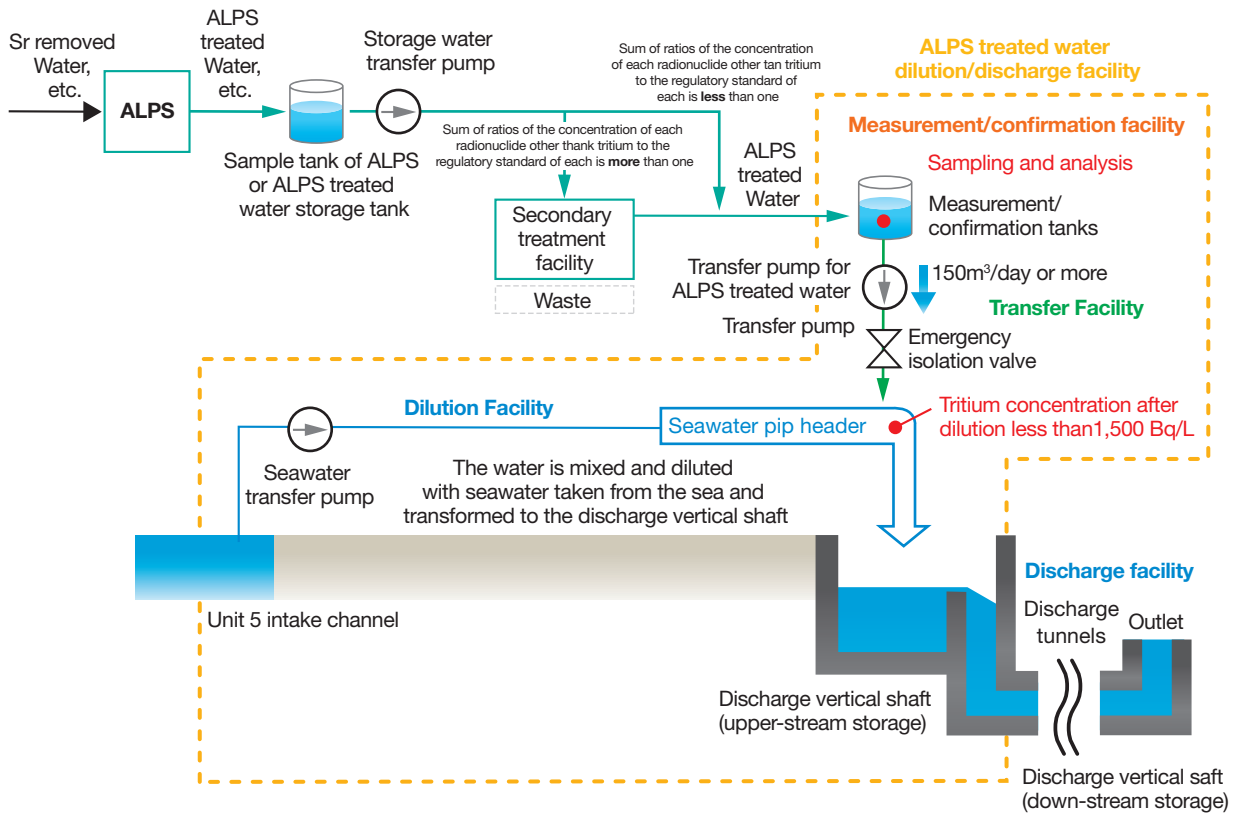

Figure 3.20. ALPS processing, storage and discharge facilities

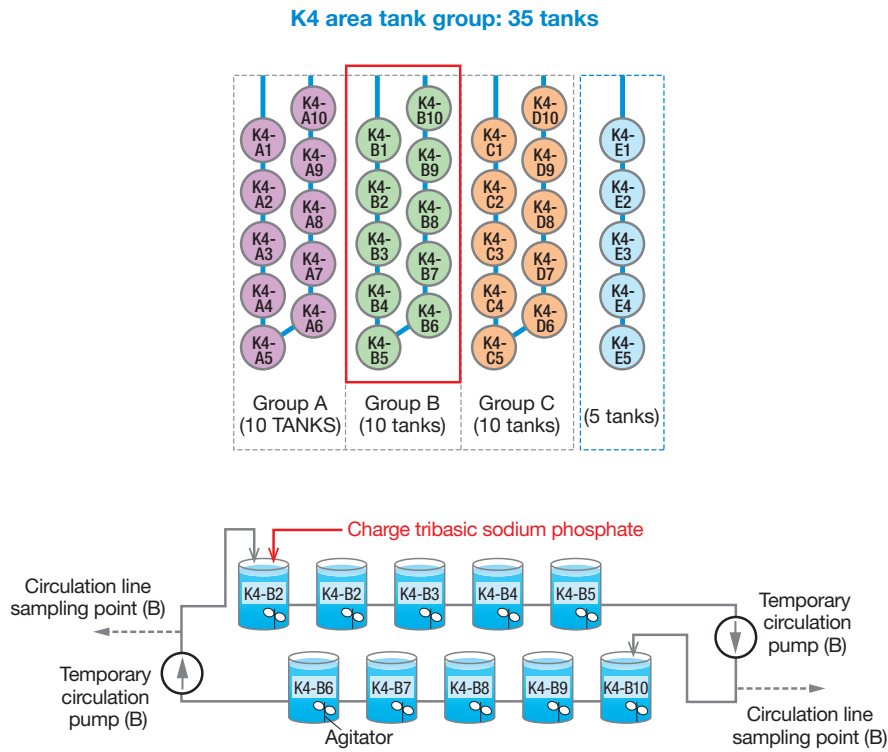

Figure 3.21. Infrastructure used by TEPCO to ensure homogeneity of ALPS treated water in the measurement and confirmation facility

Homogeneity and representative sampling

To ensure that samples taken from each batch are representative, achieving homogeneity in the measurement and confirmation tanks is fundamental. TEPCO has carried out an experiment to demonstrate how it intends to achieve homogeneity through agitation (intra-tank) and circulation (inter-tank).

The experiment was based on the addition of a known concentration of a stable, easy to measure tracer – tribasic sodium phosphate – into the tank group contents (see Figure 3.21). Circulation and agitation was then performed. Samples of the phosphate tracer were taken beforehand, while circulation and agitation was in progress and after 144 hours (6 days) had passed when there was indication that sufficient homogeneity within the tank group contents had been achieved. Analysis of the latter samples, 30 in total taken at three locations – upper (10m), middle (5m) and lower (1m) – from each of the 10 individual tanks demonstrated a relative standard deviation in phosphate concentrations of 10.5%. There was also consistency, within measurement uncertainty, between the known volume of phosphate added and that determined following dilution in the tank group contents from these measurements.

TEPCO also analysed the 30 samples for activity concentrations of tritium and other radionuclides that could be detected (^{60}Co , ^{90}Sr , ^{129}I , ^{137}Cs) and compared them to results from before the homogeneity test [19]. The relative standard deviation for tritium was 1.9%, reduced from 8.1%. The degree of heterogeneity in activity concentrations measured at each point in each individual tank was also demonstrated to be lower for the other radionuclides, with the exception of ^{60}Co which effectively remained the same. The relative standard deviations for these radionuclides following circulation and agitation ranged from 4.5% to 14.9%.

On the basis of this experiment, TEPCO concluded that an adequate degree of homogeneity that would allow for representative samples to be taken had been achieved. Equivalent equipment for circulation and agitation has been incorporated into its operational plan for managing the discharges.

To ensure the ongoing effectiveness of this process, the maintenance of this equipment is included in the general maintenance plan for the measurement and confirmation facilities that TEPCO has developed. TEPCO shared this maintenance plan with the IAEA and has submitted it to the NRA for approval as part of the NRA's inspection programme.

Measurement and confirmation

The radionuclides to be measured and confirmed as being below regulatory limits prior to discharge of each batch of ALPS treated water are those identified in the source term (see Section 3.3).

The detection limit of each method is informed by the regulatory limit for discharge of each respective radionuclide – TEPCO's target for detection limits is <1% of the respective regulatory limit. The results of the first ILC for corroboration of source monitoring [1] showed that they have achieved this detection limit for all 30 radionuclides in the ALPS treated water source term (see Table 3.10).

A lot of radionuclide-specific measurement data exist – over many years since 2011, from different points in the processing stream, covering a broad range of radionuclides. These include long-lived, high-yield fission and neutron activation products, and isotopes of uranium and transuranics, including isotopes of Np, Pu, Am, and Cm.

TABLE 3.10. COMPARISON OF TEPCO'S DETECTION LIMITS WITH RESPECTIVE JAPANESE REGULATORY LIMITS FOR DISCHARGE (Table 9 [1])

	Regulatory limit (RL) (Bq/L)	Detection limit (DL) (Bq/L)	DL relative to RL (%)
³ H	60000	210	0.35
¹⁴ C	2000	1.6	0.080
⁵⁴ Mn	1000	0.047	0.0047
⁵⁵ Fe	2000	19	0.94
⁶⁰ Co	200	0.028	0.014
⁶³ Ni	6000	8.1	0.13
⁷⁹ Se	200	0.85	0.43
⁹⁰ Sr	30	0.069	0.23
⁹⁹ Tc	1000	0.43	0.043
¹⁰⁶ Ru	100	0.42	0.41
¹²⁵ Sb	800	0.10	0.013
¹²⁹ I	9	0.026	0.29
¹³⁴ Cs	60	0.057	0.10
¹³⁷ Cs	90	0.036	0.040
¹⁴⁴ Ce	200	0.59	0.30
¹⁴⁷ Pm	3000	0.32	0.011
¹⁵¹ Sm	8000	0.012	0.00015
¹⁵⁴ Eu	400	0.072	0.018
¹⁵⁵ Eu	3000	0.19	0.0063
²³⁴ U	20	0.031	0.15
²³⁸ U	20	0.031	0.15
²³⁷ Np	9	0.031	0.34
²³⁸ Pu	4	0.031	0.76
²³⁹ Pu	4	0.031	0.76
²⁴⁰ Pu	4	0.031	0.76
²⁴¹ Pu	200	0.84	0.42
²⁴¹ Am	5	0.031	0.61
²⁴⁴ Cm	7	0.031	0.44

TEPCO has put significant effort into characterizing the source term and, because this is already more than sufficiently conservative, the IAEA supports using the list of radionuclides identified as a basis for source monitoring. IAEA does not recommend monitoring for additional radionuclides, especially those identified in early iterations of the methodology. These include short-lived radionuclides. Monitoring for these radionuclides that could not possibly be present in the water more than 12 years after cold shutdown could result in confusion.

TEPCO has established a quality management system (QMS) for the analysis of radionuclides (for both source and environmental monitoring). The NRA inspects this and other laboratory and quality manuals before the start of operation, and as necessary once the discharges are in option. The aspects of TEPCO's QMS subject to inspection include procurement, analytical method development, human resources and training, maintenance and calibration of instruments, and document management and record keeping. Each of these has been linked to relevant clauses of ISO 9001 [20] and ISO/IEC 17025 [21] as evaluation criteria that are utilised during NRA's inspections.

TEPCO's sampling and analytical methods for both source and environmental monitoring related to ALPS treated water have also been reviewed by the IAEA. This involved both desktop and onsite components (a technical review of TEPCO's laboratories at FDNPS was conducted March 2023), in which a representative example of relevant technical records at TEPCO's FDNPS laboratories were assessed.

ALPS treated water has been characterized for alpha emitters as per the source term. Reported activity concentrations are often <1/100th of the regulatory limit. To ensure effective use of resources and optimization of analysis time whilst remaining fit for purpose, the utilization of a gross alpha screening method is justified. A pre-defined action limit is set, and if it is exceeded, a structured response plan is in place.

When discharges are operational, daily monitoring of tritium in samples of diluted ALPS treated water collected from the discharge piping after dilution will also be undertaken by TEPCO to ensure that there is compliance with the discharge limit of 1,500 Bq/L for tritium. This sampling point will be closest to the discharge point and, being diluted, the samples will be identical to the ALPS treated water actually released into the environment.

Independent monitoring by NRA

GSG-9 requires that independent monitoring should be undertaken by the regulatory body or on behalf of the regulatory body by another organization that is independent of the operating organization.

The NRA has undertaken a verification of TEPCO's source monitoring. It contracted a Technical Support Organization (TSO) laboratory (JAEA, Nuclear Safety Research Centre) to analyse a sample of ALPS treated water taken prior to the start of discharges for a subset of radionuclides: tritium, ^{14}C , ^{36}Cl , ^{55}Fe , ^{60}Co , ^{79}Se , ^{90}Sr , ^{99}Tc , ^{106}Ru , ^{125}Sb , ^{129}I , ^{134}Cs , ^{137}Cs . The sample was taken at the same time as those used for the IAEA's 1st ILC for corroboration of source monitoring [1]; TEPCO reported identical results for both exercises. For radionuclides for which activity concentrations above detection limits were reported by both TEPCO and JAEA, the results were compared against TEPCO's results using scores [22]. All such results (tritium, ^{14}C , ^{60}Co , ^{90}Sr , ^{99}Tc , ^{129}I , ^{137}Cs) were found to be in agreement, although JAEA were required to re-analyse the sample for ^{14}C .

Additionally, NRA requires that certain radionuclides are analysed for their presence in ALPS treated water (separate from the analytical comparison with TEPCO results) as an additional level of independent assessment. The analytical results prepared for NRA include the identification of any discrepancies and their potential cause. NRA explained the process for responding to discrepancies between the independent monitoring and TEPCO measurements and that the information required for a root cause analysis (e.g., quality assurance and control processes, analytical method/instrumentation used) should be defined in advance.

Samples collected from the K4-B tank group were the focus of the IAEA's first Interlaboratory Comparison (ILC) for corroboration of source monitoring [1] and Section 4. The results of this ILC confirmed the appropriateness of TEPCO's analytical methods and sample collection procedures, including the techniques used to ensure homogeneity and thus to obtain representative samples.

Environmental monitoring

Monitoring of the marine environment involves the measurement of radionuclide concentrations in environmental media (including seawater, sediments, seafood and flora and fauna). The objectives

of environmental monitoring are to verify the results of source monitoring and the adequacy of the assumptions made for the assessment of public exposure and the assessment of radiological environmental impacts. Additional reasons for environmental monitoring are to detect any unpredicted changes in activity concentrations and to evaluate long term trends; to provide data to enable the assessment of actual or prospective doses to the reference person; and to provide information to the public.

Environmental monitoring is conducted off-site. The activity concentrations detected in environmental monitoring are normally lower than those estimated by conservative models, and, consequently, retrospective dose calculations are often based on source monitoring data and appropriate modelling.

The Government of Japan's Comprehensive Radiation Monitoring Plan (CRMP) [7] is a coordinated initiative undertaken by government agencies aimed at monitoring and managing radiation levels throughout the country. It is coordinated jointly by the Ministry of Environment and NRA. It was developed in April 2011 in response to the accident at FDNPS and has been reviewed and revised as necessary each year since [7]. The objectives of the CRMP include:

Monitor Radiation Levels: The CRMP has established a comprehensive monitoring system to continuously measure radiation levels in environmental media, including air, soil, water, and food.

Assess Health Risks and Plan and Evaluate Interventions: The collected data are analyzed to assess the potential health risks associated with radiation exposure. This includes evaluating the impact on individuals, communities, and the environment, and identifying any areas or populations that may require specific attention or intervention such as decontamination or re-evaluation of evacuation zones.

Ensure Transparency and Communication: The CRMP emphasizes effective communication of the results of monitoring to the public. By providing accurate and accessible information, the plan aims to enhance public awareness, understanding, and confidence in radiation monitoring efforts.

Environmental Protection: The CRMP focuses on safeguarding the environment, including marine ecosystems, from the potential impacts of radiation. It includes monitoring and assessing the transfer of radioactivity between different environmental compartments, for example seawater, marine sediments and biota such as fish, shellfish and seaweed.

The marine monitoring component of the CRMP defines sampling locations, frequency of sampling, detection limits and responsibilities of the organizations involved. Monitoring comprises sampling and analysis of seawater to different depths, sediment and marine biota (fish, shellfish and seaweed) and is separated into zones at varying distances from the FDNPS site which are: the sea area close to FDNPS; the coastal area; the off-shore area; and the outer sea area. The aim of this plan includes ensuring a comprehensive overview of the radiological situation in the marine environment and providing an adequate basis for assessments of radiation exposures from marine pathways.

With a view to assisting the Government of Japan in its objective of making the marine monitoring component of the CRMP comprehensive, credible and transparent, the IAEA, through its Marine Environment Laboratories, is helping to ensure the high quality of data and to prove the comparability of the results. A project 'Marine Monitoring: Confidence Building and Data Quality Assurance' was initiated in 2014 as a follow-up activity to recommendations made on marine radioactivity monitoring in a report issued by the IAEA in 2013 which reviewed Japan's efforts to plan and implement the decommissioning of the FDNPS. The project has been extended several times since. So far, 10 sampling missions and interlaboratory comparisons (ILCs) and 7 proficiency tests (PTs) have been completed and the project is ongoing.

To date the results of the ILCs, published as IAEA reports, for example [26; 27], have concluded that Japan’s sample collection procedures follow the appropriate methodological standards required to obtain representative samples and that Japanese laboratories involved in the analyses of radionuclides in marine samples for the CRMP demonstrate a high level of accuracy and competence. These results are backed up by the conclusions of the PTs. More information on this work is available through a dedicated website⁶.

The IAEA is also corroborating the results of environmental monitoring undertaken specifically to address the discharges of ALPS treated water (see Part 4.2 and this Section).

The locations at which samples are collected for analysis in interlaboratory comparisons for the near shore sea area, coastal sea area and offshore sea area [28].

Revision of Japan’s Comprehensive Radiation Monitoring Plan

Japan’s Comprehensive Radiation Monitoring Plan (CRMP) has, since March 2022, been revised to address ALPS treated water discharges. An expert group (nominated by the Government of Japan) provided guidance on the enhancement of the CRMP to address the ALPS treated water discharges and will continue to be utilized to provide advice on details of the environmental monitoring taking place around FDNPS. An overview of the interaction of the expert group with the MOE (coordinator of marine monitoring within the CRMP), the NRA and TEPCO as a data provider is schematized in Figure 3.22. The expert group has considered the parameters set regarding location and frequency of environmental sampling and will also be involved in reviewing the monitoring data. The coordination of the organisations contributing to the CRMP and the expert group is presented in Figure 3.22.

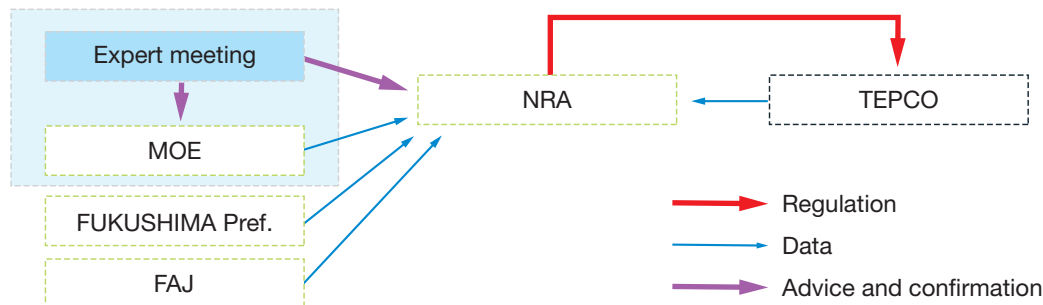

Figure 3.22: The interaction of the expert group with the MOE (coordinator of marine monitoring within the CRMP), the NRA and TEPCO

The revised plan includes monitoring of tritium in seawater at an increased frequency plus the identified “seven major radionuclides” in seawater quarterly. Monitoring of organically bound tritium (OBT), free-water tritium (FWT) and ¹⁴C in fish and ¹²⁹I in seaweed has also been undertaken.

As already stated in Section 3.4, the radionuclides contributing most to ingestion doses - over 90% of the total – are ¹²⁹I, ¹⁴C, ⁵⁵Fe and ⁷⁹Se. These radionuclides are included in the CRMP: ¹²⁵I is measured in seaweed (as a bioindicator); ¹⁴C (in fish); and ⁵⁵Fe and ⁷⁹Se in seawater once a year.

⁶ <https://www.iaea.org/about/organizational-structure/department-of-nuclear-sciences-and-applications/division-of-iaea-marine-environment-laboratories/marine-monitoring-confidence-building-and-data-quality-assurance>

Baseline monitoring

Baseline monitoring has started and is in line with GSG-9 recommendations on conducting a preoperational analysis (before the discharges start) to determine the existing levels of background radiation in the environment surrounding the facility prior to the first discharge and to establish a baseline. It is also in accordance with the possible need for more frequent and detailed environmental measurements suggested by RS-G-1.8 [16], which may be needed in the early stages of operation. The monitoring programmes should be reviewed periodically to ensure that it continues to be relevant for its purposes.

The baseline monitoring, along with measurements made in the vicinity of Japan and the wider Asia Pacific region is important to establish ‘background’ levels of radionuclides in the oceans and marine biota and seafood. The activity concentrations in the marine environment estimated in the REIA are very low compared to the available measured values in the region [24]. It is expected that the results from the monitoring undertaken by TEPCO and within the CRMP will not be statistically distinguishable from the ‘background’ values, at distances of a few km from the FDNPS. Therefore, any measurable concentrations of tritium, or other radionuclides in the Asia Pacific region (or beyond) should not automatically be attributed to the discharged water from the FDNPS.

Independent monitoring by NRA

GSG-9 also requires that independent monitoring should be undertaken by the regulatory body or on behalf of the regulatory body by another organization that is independent of the operating organization. The NRA has provided details on how the results of TEPCO’s monitoring will be assessed and compared against those from the organizations independent of TEPCO under the CRMP [7]. NRA’s requirements on TEPCO for identifying and resolving discrepancies between TEPCO’s monitoring results and those from independent monitoring (CRMP) have also been described. This involves statistical analysis of the time-series of measurement results for each radionuclide from each sampling location by NRA. Any discrepancies will be evaluated against the results from neighbouring sampling locations.

Further information on the IAEA’s independent corroboration of environmental monitoring can be found in Part IV of this report.

Link of monitoring programme to REIA

The Task Force discussed with TEPCO and NRA the importance of using the environmental monitoring programme to help verify the impact of discharges on environmental concentrations and doses that have been calculated in the REIA; this is one of the roles of environmental monitoring described in the international Safety Standards.

The importance of linking reviews of the environmental monitoring programme to the results of the REIA is vitally important and was also discussed. This will ensure that environmental monitoring is focussed on the most important radionuclides and exposure pathways contributing to the doses to the public.

3.5.3 Conclusions

The IAEA has concluded that the activities and approach taken by TEPCO and NRA are consistent with the relevant international safety standards included under this section of the report. Further detailed findings are included below:

- The IAEA acknowledges that clearly defined plans for source monitoring covering sampling and analysis at the measurement and confirmation facility is in place. Additionally plans for sampling of water after dilution are also noted.
- TEPCO has put significant effort into characterizing the source term and, because this is already sufficiently conservative, the IAEA supports using the list of radionuclides identified as a basis for source monitoring.
- IAEA has found TEPCO's methodology to achieve homogeneity and thus representative samples to be appropriate.
- Quality criteria for both source and environmental monitoring have been clearly defined by the NRA and observed to have been met by TEPCO.
- Arrangements for independent monitoring by the NRA, for source monitoring, were found to adhere to the requirements of the international safety standards.
- A clearly defined plan for enhanced environmental monitoring by TEPCO and the Government of Japan to address the discharges of ALPS treated water is in place.
- The activity concentrations in the marine environment estimated in the REIA are very low compared to the available measured values in the region and these will not be distinguishable from the 'background' values, at distances of a few kilometres from the FDNPS.
- Due to the unique nature of Japan's CRMP, government agencies (such as NRA) and TEPCO conduct monitoring independently but according to a common plan. Arrangements for checking data for consistency and the identification and investigation of discrepancies are in place.

3.6. Involvement of Interested Parties

3.6.1 Background

In accordance with GSR Part 3 [8], the government or the regulatory body are required to provide information to, and engage in consultation with, parties affected by its decisions and, as appropriate, the public and other interested parties.

In the IAEA international safety standards, the term interested parties is used in a broad sense to mean a person or group having an interest in the activities and performance of an organization. In the context of radioactive discharges to the environment, 'interested parties' typically include individuals or organizations representing members of the public; industry; government agencies or departments whose responsibilities cover public health, nuclear energy and the environment; scientific bodies; the news media; environmental groups; and groups in the population with particular habits that might be affected significantly by the discharges, such as local producers and indigenous peoples living in the vicinity of the facility or activity under consideration.

GSR Part 3 [8] states:

“3.124. When a source within a practice could cause public exposure outside the territory or other area under the jurisdiction or control of the State in which the source is located, the government or the regulatory body: ...

(c) Shall arrange with the affected State the means for the exchange of information and consultations, as appropriate.”

Paragraph 5.99 of GSG-9 [9] states: “Because the regulatory control of radioactive discharges takes into account both operational and societal aspects, such as radioactive waste management in the facility and the optimization of the level of protection of the public, there are a number of different interested parties whose views should be considered, as appropriate. A process resulting in the granting of an authorization for discharges is likely to necessitate an exchange of information between the regulatory body, the applicant, and other interested parties. Some interested parties may be located in other States, especially in neighbouring States.”

Paragraph 5.101 of GSG-9 [9] further notes that:

“In some cases, there may be specific requirements for the exchange of information with interested parties before the authorization for discharges has been finalized. One means of doing this is through the establishment of a group reflecting local public concerns for liaison with both the operating organization and the regulatory body. Among other things, the results of the prospective radiological environmental impact assessment should be a focal point of the discussions.”

Any exchange of information relating to the control of discharges may form part of other decision making processes. Such exchange of information should include consideration of societal aspects, for example public concern over the risks associated with radiation exposure, and consideration of the doses to the public that might result from discharges during operation.

3.6.2 Review and Assessment

Throughout the safety review, the Task Force carefully considered how the Government of Japan, and TEPCO, involved interested parties in their activities and planning for the discharge of ALPS treated water. In general, the Task Force used the issuance of the Basic Policy by the Government of Japan as the starting point for consideration of this topic, but when available, the Task Force appreciated additional more historical data provided by METI, TEPCO, or NRA that would help to provide useful background information.

METI provided an overview of the primary means through which METI, MOFA, and TEPCO engage with interested parties. These include briefing sessions for diplomatic missions in Tokyo (more than a hundred such sessions had been held since 2011), bilateral interactions through various forms of communication with other Governments or authorities, including those of neighbouring countries and regions, conduct of site tours, presentations at technical conferences, public reports that detail the progress of the site decommissioning and presentation of environmental monitoring results, publishing information in international periodicals to ensure the public is made aware of developments.

METI noted that the Government of Japan has been engaging with the public on the issue of handling ALPS treated water for many years; however, the past two to three years have seen many opportunities to share relevant updates and developments with interested parties. METI also noted that some outreach to

neighbouring countries has been conducted in the native language of those countries to facilitate a better understanding and exchange of views.

METI further highlighted that owing to intense communication efforts over the past 10 years, the public is reasonably familiar with safety concepts and how these relate to the decommissioning of the Fukushima Daiichi Nuclear Power Station. However, more nuanced concepts such as risk reduction and optimization of decommissioning, which are also relevant to the handling of ALPS treated water, are still not widely understood by the general public.

The Task Force noted that the involvement of interested parties can improve the understanding of the characteristics of the representative person and the acceptability of resulting estimated dose with site-specific habit data provided by relevant interested parties, and that involvement of interested parties is seen as an important input to the optimization process. The Task Force also noted that the long-term nature of the proposed discharge could present unique or different communication needs and TEPCO could consider elaborating a plan to describe the involvement of the interested parties throughout the duration of the project. In particular, the Task Force stressed the importance of maintaining awareness of changes in the local area (e.g., use of the land) and population habits as that could have a direct impact to the assumptions in the REIA and the definition of the representative person.

The Task Force also highlighted the critical role of a regulatory body in ensuring interested parties are involved and their views considered as part of the authorization process. Throughout the review, the NRA provided periodic updates of their progress and how the involvement of interested parties was factored in. This primarily considers two different approaches: 1) public comment periods for key regulatory documents and milestones, and 2) outreach and engagement activities conducted specifically by the regulatory body for interested parties in local, national, and international settings.

The NRA provided an overview of the actions undertaken for public communication and involvement of interested parties. The NRA highlighted that their main message to the public on ALPS Treated Water Discharge is: *“ALPS treated water discharge does not have substantial adversary effects to health and the environment as far as satisfying the regulatory requirements and it is necessary to progress the decommissioning of the FDNPS.”*

After TEPCO submitted amendments to their implementation plan to facilitate the discharge of ALPS treated water at FDNPS, the NRA and TEPCO have been participating in regular review meetings to discuss TEPCO’s plan. These review meetings are open to the public, both for in-person attendance and via web-streaming. All materials, including the minutes of the meetings, are posted on the NRA website, and are also made available in English. The NRA explained that they intend to publish the draft result of their review, solicit public comments and reflect such comments to the draft as appropriate. More specifically, the draft results will be posted on the Government website in Japanese, and the English version will also be provided for reference. The period for receiving comments from the public is generally set at one month. For the first review of the revised Implementation Plan, as an example, the NRA noted that the review results were available for 30 days and after this period closed they report 1,233 received comments. As part of its second mission to NRA, the Task Force requested further information about how the public comments are handled. NRA noted that they are first reviewed for technical relevance to the topic at hand (i.e., discharge of ALPS treated water) then further organized into key topics and duplicate comments/questions are condensed. The NRA issued its regulatory approval of the revised Implementation Plan on 10 May 2023 only after fully considering the feedback received.

The NRA highlighted to the Task Force their communication framework at the national level that consists of the following components:

- Local government meetings held in prefectures around Fukushima;

- Explanations provided to political parties and interested groups after the adoption of the Basic Policy;
- National diet⁷ sessions where the status of NRA's review and future schedules have been raised;
- Regular press conferences for the provision of updated information to the public;
- NRA's website where NRA posts the materials and minutes of the review meetings.

At the international level, the NRA has held meetings with other countries and organizations and explained the up-to-date status around the ALPS treated water discharge. The NRA has provided and indicated their willingness to continue to provide information to neighbouring states as appropriate, including through the framework for cooperation among regulatory bodies, and the NRA response to questions submitted by other countries.

The Task Force commented positively on the efforts undertaken by the NRA and noted that the NRA is following a comprehensive approach in their communication with interested parties. In future engagements the Task Force noted the importance of:

- Using appropriate language and presentation means when communicating with the public.
- Clarifying the difference in risks associated with ALPS treated water discharge from those associated with overall decommissioning of the site.
- Ensuring that the actions undertaken by the NRA are presented in an open and transparent manner and can be reviewed by interested parties in the future.

3.6.3 Conclusions

The IAEA has concluded that the activities and approach taken by TEPCO and NRA are consistent with the relevant international safety standards included under this section of the report. Further detailed findings are included below:

- The approaches for engagement with local, national and international interested parties will differ, however the need to address the views of interested parties over the entire length of the proposed discharge will remain an important factor for sustainability.
- The identification of interested parties by the Government of Japan, and TEPCO, was conducted in such a way to ensure that a wide range of interested parties have been included in the associated outreach and communication efforts.
- The Government of Japan, TEPCO, and NRA have provided information to and engaged in consultations with the parties that are affected by the planned discharge of ALPS treated water. This includes both international, and domestic, interested parties.
- The involvement of interested parties in the domestic regulatory authorization process managed by NRA has been clearly demonstrated.
- TEPCO and METI have conducted significant outreach activities to ensure transparency.

⁷ The National Diet is Japan's bicameral legislature and it is the highest organ of State power.

3.7. Occupational Radiation Protection

3.7.1 Background

Control, monitoring, assessment and recording of occupational exposure are essential for proper management of radiation protection of workers in any workplace. GSR Part 3 [8] sets requirements applicable to the regulatory body as well as to registrants or licensees. These requirements include the establishment of dose limits for workers, optimization of protection and safety of workers, including dose constraints applied to occupational exposure control in planned exposure situations through a licensing process.

Occupational radiation protection has a strong operational emphasis and GSR Part 3 also sets requirements for establishing and maintaining organizational, procedural and technical arrangements for the designation of controlled areas and supervised areas, for local rules and for monitoring of the workplace, in a radiation protection programme with necessary guidance provided by GSG-7 [23].

Paragraph 5.3 of GSG -7 states that:

“Contamination of areas can arise from facilities and activities that are subject to regulatory control in terms of the requirements for planned exposure situations, as a result of authorized activities such as discharges, the management of radioactive waste and decommissioning. An exposure situation resulting from such contamination is controlled as part of the overall practice and is, therefore, a planned exposure situation and not an existing exposure situation.”

The responsibilities of the regulatory body specific to occupational exposure in planned exposure situations are laid out in Requirement 19 and paras 3.69–3.73 of GSR Part 3 [8]. The regulatory body is required to establish and enforce requirements to ensure that protection and safety is optimized and is required to enforce compliance with the applicable dose limits. Further, the regulatory body is responsible for the establishment and enforcement of requirements for the monitoring, recording and control of occupational exposures in planned exposure situations in accordance with the requirement 25 of GSR Part 3 [8], and for the review of monitoring programmes of registrants and licensees.

Requirement 21 of GSR Part 3 [8] states that: *“Employers, registrants and licensees shall be responsible for the protection of workers against occupational exposure. Employers, registrants and licensees shall ensure that protection and safety is optimized and that the dose limits for occupational exposure are not exceeded.”*

In planned exposure situations, employers, registrants and licensees are responsible for ensuring that appropriate radiation protection programmes are established and implemented in accordance with the requirement 24 of GSR Part 3 [8], including organization of radiation protection (management), radiation dose and medical surveillance of occupationally exposed workers (radiation work categories & surveillance), area and zoning based on radiation exposure conditions / pathways, work permit, training, procedures and control arrangements.

Requirement 22 of GSR Part 3 [8] states that: *“Workers shall fulfil their obligations and carry out their duties for protection and safety.”* This requirement reflects that workers can by their own actions contribute to the protection and safety of themselves and others at work. For contractors providing specialized services (in the case of ALPS, entire operation is conducted by contractors), legislative arrangements are required for employers to ensure that workers of contractors, including subcontractors, are provided

with the necessary information on radiological characteristics of the workplace and the management of facilities should ensure that contractors carry out work with competent personnel.

In accordance with the GSR Part 3 [8] and GSG-7 [23], special attention should be given to the establishment and maintenance of a national dose registry as a central point for the collection and maintenance of dose records. The storage of information at the national dose registry should be designed to allow workers, during and after their working life, to retrieve information on the doses they received while being occupationally exposed.

Coordination of different authorities with responsibilities for safety within the regulatory framework including safety of workers is required by GSR Part 1 (Rev.1) and arrangements for protection of workers is considered in the process of applying graded approach to review and assessment of the facility or activity [14, 8].

Radiation protection of workers is only one element in ensuring the overall health and safety of workers and should be established and implemented in close cooperation with those responsible for other areas of health and safety such as industrial hygiene, industrial safety and fire safety (para 3.50 of GSG-7 [23]).

3.7.2 IAEA Review and Assessment

Arrangements under the Radiation Protection Programme

The Nuclear Regulation Authority (NRA) and the Ministry of Health, Labor and Welfare (MHLW) are the primary governmental authorities responsible for the implementation of the legislative requirements concerning occupational exposure through “the Reactor Regulation Act” (which includes provisions for the establishment of controlled areas, measuring and recording of air dose rates of controlled areas, measures to control exposure of radiation workers and special education) and “the Industrial Safety and Health Act” (which includes provisions for medical examinations and delivering exposure records to the designated institution), respectively. The NRA described their role during the March 2022 mission in the establishment of dose limits for occupational exposure, and also in the approval of an operational safety programme (including arrangements for monitoring and recording of occupational exposures). The NRA explained that optimization of the radiation protection of workers at Fukushima Daiichi Nuclear Power Station (FDNPS) is conducted using dose limits and concentration limits for radioactive materials in the air inhaled by workers with limits prescribed by the NRA.

The Tokyo Electric Power Company (TEPCO) explained during the first mission that the entire site is designated as a controlled area and arrangements are in place for individual and workplace monitoring of occupational exposure according to “the Radiation Controlled Area Measuring Guide” and “the Guide for Management of Setting, Releasing and Changing of Controlled Areas and Managed Areas”.

Radiation Protection Programme (RPP)

Registrants and licensees are responsible for protection and safety. These responsibilities include the performance of an appropriate safety assessment and the establishment and maintenance of a system of protection and safety to protect workers against exposure.

The RPP for occupational exposure, which is a combination of good design, high quality construction and proper operation, primarily includes, as appropriate (Paragraph 3.60 of GSG-7):

- a) The maintenance of organizational, procedural and technical arrangements for the designation of controlled areas and supervised areas, for local rules and for monitoring of the workplace;
- b) The assessment and recording of occupational exposure;
- c) Workers' health surveillance;
- d) Provision of adequate information, instruction and training.

References: [8; 24]

Assessment and Recording of Occupational Exposure and Workers' Health Surveillance

Specific to ALPS treated water discharge facility, occupational exposures are associated with the construction, operation and maintenance of systems required for the discharge. TEPCO explained in the November 2022 mission that all workers entering the management area of FDNPS (the entire site is considered a controlled area) are required to use personal protective equipment (PPE) and individual passive /active dosimeters provided by authorized technical service providers operated under a quality management system, regardless of the magnitude of the exposure. Additionally, all workers are monitored periodically by in-vivo radiobioassay for internal exposure due to ¹³⁷Cs, using a whole body counter with plastic scintillation detectors. Nasal cavity sampling and monitoring for ⁹⁰Sr is conducted at FDNPS, and a software called "Monitoring to Dose Calculation" (MONDAL) is used for internal dose assessment.

TEPCO provided information on the individual monitoring programme for exposures from intakes of radionuclides which is conducted for identified workers who are exposed over recording levels due to contamination as well as those who use respiratory protective equipment. TEPCO explained that occupational exposure data for workers, including contractors, is gathered, stored, and maintained by TEPCO and submitted to a central database. Also, a programme for workers' health surveillance is conducted in the FDNPS, consisting of medical checks every 6 months with necessary record keeping arrangements based on the "Health Monitoring Manual" and the "Long-term Healthcare Manual".

TEPCO provided information explaining that the requirement for dose assessment and optimization applies only where the doses of workers are likely to exceed certain levels and therefore only a small proportion of the workforce would need to be assessed. TEPCO will carry out further workplace and individual monitoring programmes, as appropriate, for dose assessment purposes and for providing warning of changing exposure conditions. TEPCO explained that for all work conducted in the facility, there are radiation control plans in place, submitted by the responsible organization (including contractors) and validated by TEPCO. Meetings to discuss the control of exposure in work plans (so-called 'ALARA' meetings) are organized in advance at the planning stage.

In addition, TEPCO explained that internal doses due to tritium are low. Tritium is measured as HTO in water and then its concentration in the air is estimated. TEPCO added that all workers wear appropriate personal protective equipment although exposure due to inhalation is not expected.

The NRA provided detailed information during the January 2023 mission about the basis for regulatory oversight with regard to monitoring requirements (e.g., implementation of investigation levels and recording levels) through the implementation of the NRA Ordinance for FDNPS, and NRA Notification for FDNPS. Regarding occupational exposure record keeping, the NRA explained that the Radiation Effects Association (Radiation Dose Registry Center, RADREC) is the registry institution of dose records of radiation workers (i.e., nuclear workers, radioisotope workers, and decontamination workers) as stipulated in the NRA Ordinance for FDNPS.

Monitoring and recording of occupational exposure

The personal (individual) monitoring of workers for occupationally exposed workers and the recording of the radiation doses received by workers for proper occupational exposure control are important aspects of any Radiation Protection Programme.

Paragraph 3.105 of GSR Part 3 states that: “Records of occupational exposure shall include:

- a) Information on the general nature of the work in which the worker was subject to occupational exposure;
- b) Information on dose assessments, exposures and intakes at or above the relevant recording levels specified by the regulatory body and the data upon which the dose assessments were based;
- c) When a worker is or has been exposed while in the employ of more than one employer, information on the dates of employment with each employer and on the doses, exposures and intakes in each such employment;
- d) Records of any assessments made of doses, exposures and intakes due to actions taken in an emergency or due to accidents or other incidents, which shall be distinguished from assessments of doses, exposures and intakes due to normal conditions of work which shall include references to reports of any relevant investigations.”

GSG-7 provides guidance for the collection, analysis, and dissemination of occupational radiation exposure information in the form of national dose registry as a central point for the collection and maintenance of dose records.

Optimization of occupational exposure

The NRA explained that optimization of the radiation protection of workers at FDNPS is conducted using dose limits and concentration limits for radioactive materials in the air inhaled. Some Task Force members highlighted that there is no single way to implement optimization of occupational exposure and added that the approach followed by the NRA is well documented.

TEPCO benefits from the implementation of optimization of protection and the use of dose constraints for the radiation protection of workers in addition to their own long-term operational experience. TEPCO effectively utilizes safety measures such as target values, daily dose follow-ups, and work permits related to workplace characteristics (including ALPS treated water discharge facility).

Optimization of protection and safety

For occupational exposure, optimization of protection and safety should be considered at all stages in the lifetime of equipment and installations, in relation to both exposures from normal operations and potential exposures. Optimization is an obligation of means, and not an obligation of results in the sense that the result of optimization depends on processes, procedures, and judgements and is not a given value of dose or exposure. The result of optimization depends on processes, procedures, and judgements and is not represented by a given value for exposure.

Paragraph 1.23 of GSR Part 3 [8] states that: “... For occupational exposure, the dose constraint is a tool to be established and used in the optimization of protection and safety by the person or organization responsible for a facility or an activity.... After exposures have occurred, the dose constraint may be used as a benchmark for assessing the suitability of the optimized strategy for protection and safety...that has been implemented and for

making adjustments as necessary. The setting of the dose constraint needs to be considered in conjunction with other health and safety provisions and the technology available.”

3.7.3 Conclusions

The IAEA has concluded that the activities and approach taken by NRA and TEPCO are consistent with the relevant international safety standards included under this section of the report. Further detailed findings are included below:

- Relevant regulatory arrangements in Japan for occupational radiation protection are consistent with the relevant international safety standards. The IAEA confirms that NRA’s approach to enforce the occupational exposure control, monitoring, assessment and recording is sufficient.
- TEPCO has a reliable and sustainable radiation protection programme. The IAEA observed clear evidence of self-regulation by TEPCO for an advanced design and implementation of occupational exposure control measures and monitoring arrangements related to the operation of ALPS treated water discharge facility.
- Occupationally exposed workers working at FDNPS including workers involved in activities associated with the planned discharges of ALPS treated water, regardless of whether they are contractors or staff, are under the same occupational radiation protection regime.

PART 4

MONITORING, ANALYSIS, AND CORROBORATION

4.1. Overview of Corroboration Activities

The IAEA's safety review of the handling of ALPS treated water at FDNPS includes the following three components: the assessment of protection and safety; the review of regulatory activities and processes; and independent sampling, data corroboration, and analysis activities. The third component is included in the overall safety review to provide confidence in the accuracy of data provided by TEPCO and the Japanese authorities. Additionally, these corroboration activities provide another layer of assurance that TEPCO and the Government of Japan are adhering to relevant international safety standards. The IAEA's corroboration will not be exhaustive but rather is intended to allow interested parties to infer the accuracy of all the available data by validating the key data provided by the laboratories in Japan responsible for producing and publishing analytical results from the ALPS treated water discharge process. The IAEA's corroboration activities will complement the broader monitoring and verification regime that is the responsibility of the Government of Japan who maintains the overall responsibility for the safety of its nuclear facilities and activities. The IAEA's involvement is a critical element for demonstrating the accuracy and validity of data being reported by Japanese authorities related to the discharge of ALPS treated water, and therefore building confidence in the overall IAEA safety review.

Currently, the IAEA's independent sampling, data corroboration, and analysis activities include three major components:

- Sampling, analysis and interlaboratory comparison for ALPS treated water from the FDNPS.
- Sampling, analysis and interlaboratory comparison for environmental samples (e.g., seawater, fish) from the surrounding environment of FDNPS.
- Assessment of the capabilities of dosimetry service providers involved in the monitoring of internal and external radiation exposure of workers at FDNPS.

Corroboration of Source and Environmental Monitoring

The IAEA corroboration of source and environmental monitoring related to discharges of ALPS treated water from FDNPS is comprised of three distinct elements (see also Figure 4.1):

- Review of sampling and analytical methods for source and environmental monitoring related to ALPS treated water at FDNPS used by TEPCO and relevant Japanese authorities⁸.
- Corroboration of source monitoring undertaken by TEPCO, including a comprehensive radiological characterization of ALPS treated water samples.
- Corroboration of environmental monitoring undertaken by TEPCO and relevant Japanese authorities.

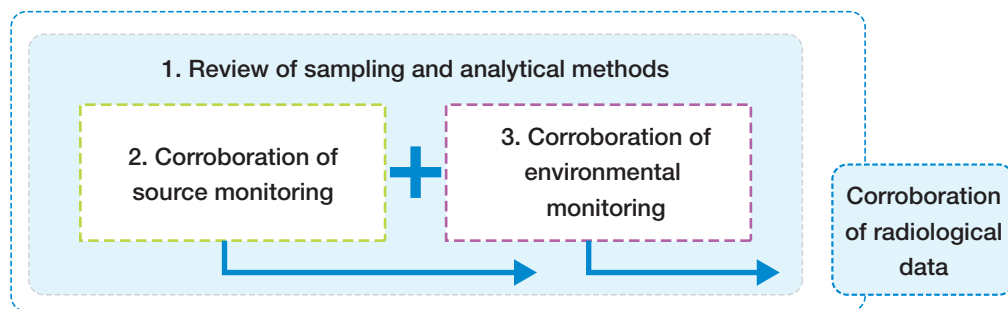

Figure 4.1: A schematic overview of the elements of the corroboration being undertaken by the IAEA laboratories and the links between these elements.

The corroboration of source and environmental monitoring will be based on interlaboratory comparisons (ILCs). ILCs, along with proficiency tests (PTs), are standard methods for laboratories to assess the quality of their measurement results in comparison with those of other participating laboratories, and to identify any potential improvements. PTs involve the evaluation of performance against pre-established criteria whereas ILCs involve the organization, performance and evaluation of measurements on the same or similar items by two or more laboratories in accordance with predetermined conditions.

For the corroboration of source monitoring, samples of ALPS treated water that is considered by TEPCO to be ready for dilution and discharge – pending final confirmation by analyses – are being collected from tanks at FDNPS. For the corroboration of environmental monitoring, samples of seawater, sediment and marine biota are being collected from locations on the east coast of Japan around FDNPS. Sample collection and pre-treatment activities undertaken by TEPCO, and relevant Japanese authorities will be facilitated and observed by the IAEA. The homogeneity of all samples will be ensured. These samples will be split, and sub-samples will be provided to the laboratories participating in the ILCs for the analysis of the activity concentrations of a range of relevant radionuclides.

Corroboration of Occupational Radiation Protection

An individual monitoring programme is designed to assess radiation doses to workers arising from exposure due to external sources of radiation and from exposure due to intakes of radionuclides. The IAEA's corroboration for occupational radiation protection capabilities is comprised of three distinct elements (see also Figure 4.2):

⁸ TEPCO has sole responsibility for source monitoring at FDNPS. All environmental monitoring related to the nuclear accident at FDNPS is conducted according to the Comprehensive Radiation Monitoring Plan (CRMP). TEPCO and other relevant Japanese authorities have responsibilities under the CRMP. In practice, sampling and analysis are often carried out by contracted laboratories. Within this report it is assumed that TEPCO and the other relevant Japanese authorities as defined in the CRMP have responsibility for reporting the results of the monitoring for which they are responsible. However, the participants in the ILCs could be the laboratories that have contracts in place to undertake analyses.

1. Corroboration of relevant Japanese individual monitoring services (IMS) capabilities for monitoring and assessing external exposure;
2. Corroboration of relevant Japanese IMS capabilities for monitoring and assessing internal exposure; and
3. Review of analytical methods in external and internal dosimetry used by the relevant Japanese IMS.

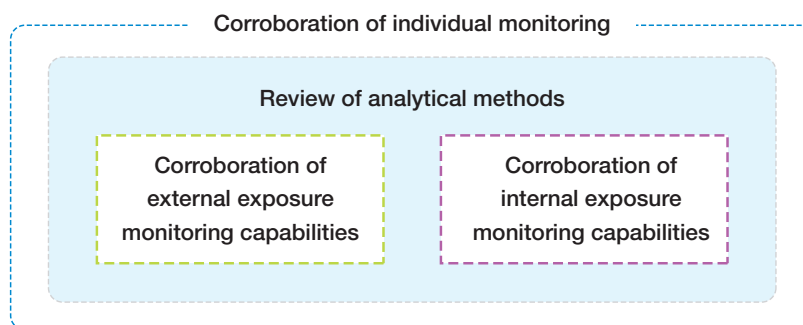

Figure 4.2. Schematic overview of the corroboration of individual monitoring.

First, the IAEA will corroborate the capabilities of IMS used by TEPCO for the assessment of occupational exposure of workers from external sources of radiation. An interlaboratory comparison (ILC) will be the principle means of accomplishing this corroboration, which will focus on TEPCO’s monitoring programme for assessing the occupational exposure of workers involved in handling ALPS-treated water. Personal dosimetry systems with integrated passive detectors will be provided by and evaluated at the IAEA Radiation Safety Technical Services Laboratory (RSTSL) and relevant Japanese IMS. Irradiation of dosimeters will be carried out in two phases for whole-body and extremity dosimeters, respectively, at primary or secondary standards dosimetry laboratories. The IAEA will also conduct a review of analytical methods relevant to external dosimetry used by the relevant Japanese IMS. The results of this review will contribute to ensuring the validity of the data generated as part of the above-mentioned ILC.

Second, the IAEA will corroborate the capabilities of IMS used by TEPCO for the assessment of occupational exposure of workers due to intake of radionuclides. An ILC will be the principle means of accomplishing this corroboration for in-vitro and in-vivo radiobioassay and will focus on TEPCO’s capabilities to detect radionuclide activities in urine reference samples and in phantoms emulating the human body. In the first phase, urine reference samples will be prepared by accredited laboratories and distributed for comparative analysis at the IAEA RSTSL and relevant Japanese IMS. In a second phase, a solid, leak-proof sliced bottle mannequin absorption (BOMAB) phantom containing exempt laminated planar radionuclide sources inserted between layers of polyethylene will be measured at body counters in Fukushima Daiichi and at IAEA Headquarters in a round-robin test. The IAEA will also conduct a review of analytical methods relevant to internal dosimetry used by the relevant Japanese IMS. The results of this review will contribute to ensuring the validity of the data generated as part of the above-mentioned ILC.

Participating Laboratories

The IAEA will involve several of its own laboratories and third-party laboratories as part of these corroboration activities. A list of the relevant IAEA laboratories is included below:

- IAEA Marine Environment Laboratories, Radiometric Laboratory (RML), Monaco.

The Radiometrics Laboratory (RML) in Monaco fosters expertise in marine radioactivity measurement, monitoring and assessment and in the application of radiotracers for marine pollution, climate change and oceanographic studies. RML operates specialised radiochemistry

laboratories and an underground counting facility for the analysis of low levels of radionuclides in marine and atmospheric samples and environmental forensics applications. The laboratory maintains an open access marine radioactivity data portal (MARIS [24]) and assists Member States to prepare for nuclear and radiological incidents or emergencies that could impact the marine environment. By supporting data quality in Member States for analyses of radionuclides in seawater, sediment and marine biota, including through production of reference materials according to an accredited quality system and PTs and ILCs, RML contributes to the credibility of monitoring and research results.

- IAEA Terrestrial Environmental Radiochemistry Laboratory (TERC), Seibersdorf, Austria.

The Terrestrial Environmental Radiochemistry (TERC) laboratory in Seibersdorf (Austria) assists Member States in assuring the quality of performed analytical work by supporting respective laboratories active in the fields of environmental radioactivity, stable isotope and trace element analysis. TERC provides technical support to Member State laboratories by providing suitable certified reference materials for calibration and quality control, by organising PTs to facilitate checks of analytical quality, by providing thoroughly tested and published analytical methods, and by training laboratories in their setup and operation.

- IAEA Isotope Hydrology Laboratory (IHL), Vienna, Austria.

The Isotope Hydrology Laboratory (IHL) in Vienna provides analytical services, training, and expert technical advice to Member States to develop their own analytical facilities and to help ensure the quality of isotope measurements conducted in their laboratories. The IHL houses state-of-the-art analytical equipment for the collection and measurement of stable and radiogenic isotopes and noble gases from water and hydrological samples and provides analytical support to the IAEA's Water Resource Programme's global hydrology monitoring networks, including the global network of isotopes in precipitation (GNIP), and the global network of isotopes in rivers (GNIR). Isotopic data produced by the IHL are included in the GNIP and GNIR databases, and are made available cost-free to Member States via the internet.

- IAEA Radiation Safety Technical Services Laboratory (RSTSL), Vienna, Austria.

The Radiation Safety Technical Services Laboratory (RSTSL) provides radiation protection services, including individual monitoring of workers (e.g., IAEA staff) for occupational exposure due to external and internal sources of radiation. Since 2006, RSTSL holds accreditation to ISO/IEC 17025 [21], demonstrating the technical competence and the impartiality of the laboratory in providing valid results.

Under the coordination of the participating IAEA laboratories, selected third-party laboratories, members of the network of Analytical Laboratories for the Measurement of Environmental Radioactivity (ALMERA) with demonstrable competence in the methods required, are also conducting analyses of samples as participants in the ILCs. ALMERA is a network comprising 190 member laboratories globally that is coordinated jointly by RML and TERC. It provides a platform for maintaining and developing capability on the determination of radionuclides in air, water, soil, sediment and vegetation that can be used for both routine and environmental emergency monitoring in the IAEA Member States.

4.2. Update on Corroboration of Source Monitoring

For the first ILC under the IAEA's ALPS safety review, the ALPS treated water samples were taken in March 2022 from the K4-B tank group at FDNPS. The water contained in the K4-B tank group is expected to be the first batch of ALPS treated water that will be discharged, only once TEPCO receives all regulatory approvals from NRA. The focus of the analysis efforts for this ILC were on the radionuclides in the source term which are included in the radiological environmental impact assessment conducted by TEPCO. Participating laboratories were also encouraged to analyse for additional radionuclides beyond the source term.

Analyses were undertaken by TEPCO and by the following three participating IAEA Nuclear Sciences and Applications Laboratories:

- IAEA Marine Environment Laboratories, Radiometrics Laboratory (RML), Monaco;
- Terrestrial Environmental Radiochemistry Laboratory (TERC), Seibersdorf, Austria;
- Isotope Hydrology Laboratory (IHL), Vienna, Austria.

Additionally, under the coordination of the participating IAEA laboratories, selected third-party laboratories, members of the network of Analytical Laboratories for the Measurement of Environmental Radioactivity (ALMERA) with demonstrable competence in the methods required, also conducted analyses of samples as participants in the ILCs.

The laboratories participating in this ILC were:

- Spiez Laboratory (LS – Labor Spiez), Switzerland
- Institut de Radioprotection et de Sûreté Nucléaire (IRSN), France
- Los Alamos National Laboratory (LANL), United States of America
- Korea Institute of Nuclear Safety (KINS), Republic of Korea

The results of the analyses undertaken at each laboratory were reported to the IAEA. For results that could be intercompared (i.e., for radionuclides for which activity concentrations above detection limits were reported by at least two laboratories) a statistical evaluation to assess agreement was carried out by the IAEA. The method used for the statistical evaluation was based on techniques currently used by the International Bureau of Weights and Measures' (BIPM) Consultative Committee for Ionizing Radiation, Section II: Measurement of Radionuclides, CCRI(II) and, thus, adhered to best international practice.

For other radionuclides, the detection limits reported by participating laboratories were compared to evaluate whether the analytical methods used by TEPCO were broadly equivalent and thus appropriate and fit for purpose.

On 31 May 2023 the IAEA published a detailed report including the results from this ILC [1]. The results are presented in tables and charts in this report. Reference is made to the relevant regulatory limit for discharge to sea for each radionuclide as appropriate. The key findings of this ILC are:

- TEPCO has demonstrated a high level of accuracy in their measurements and technical competence.
- TEPCO's sample collection procedures follow the appropriate methodological standards required to obtain representative samples.
- The selected analytical methods utilized by TEPCO for different radionuclides were appropriate and

fit for purpose.

- Neither the IAEA, nor the participating third-party laboratories, detected any additional radionuclides (i.e., radionuclides beyond what is included in the source term) at significant levels.

In the report, the IAEA notes that these findings provide confidence in TEPCO's capability for undertaking accurate and precise measurements related to the discharge of ALPS treated water. Furthermore, based on the observations of the IAEA, TEPCO has demonstrated that they have a sustainable and robust analytical system in place to support the ongoing technical needs at FDNPS during the discharge of ALPS treated water.

In October 2022, the IAEA witnessed the collection of two additional batches of samples of ALPS treated water. These samples are being used in the second and third ILCs to support the corroboration of source monitoring.

The samples were collected from the G4S-B10 and the G4S-C8 tanks. In contrast to the samples collected for the first ILC for the corroboration of source monitoring, these are standard tanks for storage of ALPS treated water and not interconnected or subject to circulation and agitation. To ensure inter-sample homogeneity in each case, ALPS treated water was first transferred to a 300 L plastic tank, then to a second 300 L plastic tank and, finally, back to the first 300 L plastic tank. Sample containers (3 L) were then filled and prepared for shipping to each participating laboratory. The sample volume was smaller for the second and third ILCs as robustness testing will not be carried out for these samples, having already been completed for the earlier samples.

As well as TEPCO and the IAEA laboratories, the ALMERA laboratory Korea Institute of Nuclear Safety (KINS) will participate in these ILCs. The IAEA's samples were received by TERC in November 2022. KINS also received its samples in in November 2022. A report including the analysis of these samples is expected to be published later in 2023.

4.3. Update on Corroboration of Environmental Monitoring

In November 2022 the IAEA participated in a sampling mission in Japan to collect environmental samples (e.g., seawater, marine sediment, fish, seaweed) for the first ILC to corroborate environmental monitoring related to discharges of ALPS treated water. These samples were collected jointly with experts from Japan according to methods mirroring existing sampling practices utilized by the IAEA for ILCs organized within the project NA3/38 (Marine Monitoring: Confidence Building and Data Quality Assurance) over the past nine years.

Participating laboratories have been instructed to submit results according to a similar protocol to that used for the first ILC for the corroboration of source monitoring. Following the evaluation of all submitted data, the results of the ILC will be made available by the IAEA in the second half of 2023. The results of future monitoring of environmental samples will be compared against this baseline to assess any measurable impacts from the future discharges of ALPS treated water.

4.4. Update on Corroboration of Occupational Radiation Protection

The results from the first ILC for occupational radiation protection will be available later in 2023. This first ILC will focus on external dosimetry for whole-body exposure, whereas future ILCs for occupational radiation protection will focus on external dosimetry for extremity exposure and internal monitoring for radionuclide intakes. ILCs for occupational radiation protection will be conducted between the IAEA's Radiation Safety Technical Services Laboratory and the individual monitoring services used by TEPCO for FDNPS workers.

In the first half of 2023, the IAEA initiated the corroboration for external dosimetry. The IAEA has issued a contract to a secondary standards dosimetry laboratory to have dosimeters irradiated under reference conditions in support of the corroboration of external dosimetry. The irradiated dosimeters will then be returned to relevant Japanese IMS and the IAEA's RSTSL for analysis.

After the relevant Japanese IMS and RSTSL have completed their analysis in the second half of 2023, the IAEA will collect and analyse the results. The IAEA will collect the results from all participating laboratories and conduct a screening to ensure that all laboratories have submitted a complete assessment package with all necessary documentation. The IAEA will draft a report highlighting the results, which will be published by the end of 2023.

Furthermore, in the second half of 2023, the IAEA will initiate the steps to conduct the corroboration for in-vitro and in-vivo internal monitoring. The IAEA will identify vendors for the urine samples spiked with certified reference materials and will ship the urine samples for in-vitro and a reference phantom for in-vivo bioassay to TEPCO as part of the ILC. RSTSL will also conduct analyses of the spiked urine samples and the phantom throughout 2024.

PART 5

FUTURE ACTIVITIES

As noted previously, this comprehensive report is a synthesis of nearly two years of work by the IAEA Task Force and includes explanations and insights over a broad range of topics that are important to understanding the overall safety of this process. The purpose of this comprehensive report is to present the IAEA's final conclusions and findings of the technical review to assess whether the planned operation to discharge the ALPS treated water into the Pacific Ocean over the coming decades is consistent with relevant international safety standards. However, once any discharges begin, many of the technical topics reviewed and assessed by the Task Force will need to be revisited at various times to assess the consistency of activities during the operation of the ALPS treated water discharges with relevant international safety standards

So far, the focus of the IAEA's review has been on ensuring consistency with with requirements in the international safety standards that apply during the pre-operational phase of the planned discharge of ALPS treated water (i.e., prior to beginning the water discharges). However, in the coming months the Task Force will shift its focus to requirements for the operator or the regulatory body that can only be assessed during operations. Additionally, the Task Force has noted that many of these technical topics that are being assessed before operations begin, should also be reviewed periodically in the future to ensure continued consistency with the relevant international safety standards.

Regarding future activities, after the publication of this report, the IAEA will continue implementing its safety review using the overall three elements highlighted below.

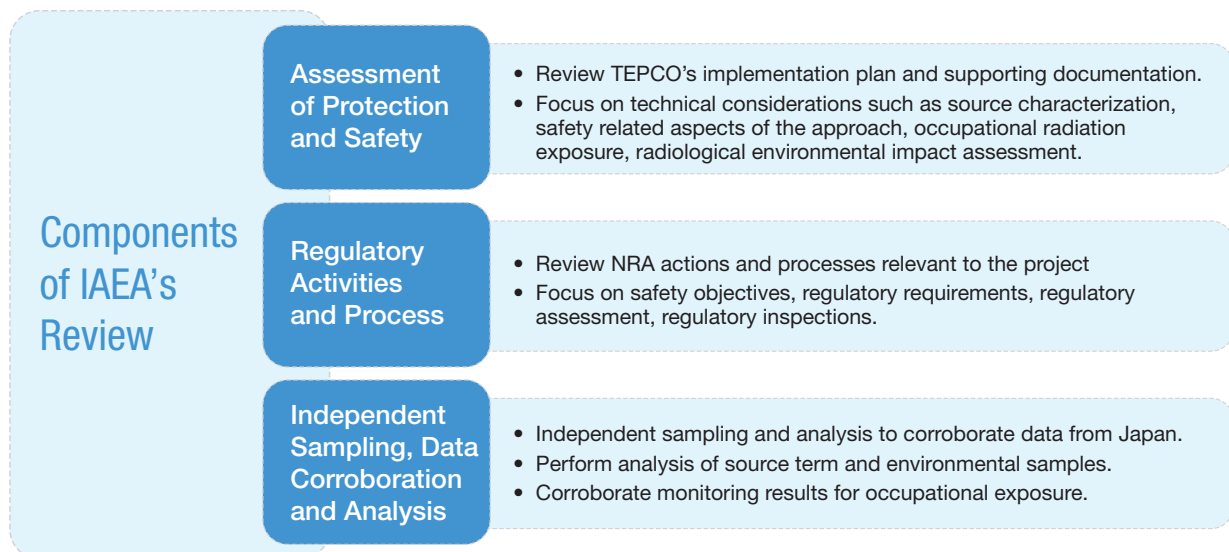

Figure 5.1 Components of the IAEA review

Additionally, the IAEA has established a presence at the FDNPS with the establishment of an IAEA site office. IAEA experts will maintain a constant presence on site for a number of weeks before and after the planned discharges of ALPS treated water. Outside of this timeframe, the IAEA experts will be on site for major activities and will be conducting monitoring as needed.

5.1. Review Missions

For the first two elements, namely the assessment of protection and safety, and regulatory activities and processes, the IAEA will utilize a similar model of conducting periodic review missions to Japan using the Task Force model with technical experts from the IAEA Secretariat and independent external experts. However, unlike in the past, future review missions will be combined given the strong connection between technical and regulatory topics. These future review missions will be guided by the main technical considerations that are highlighted in Part 3 of this report. Below is a list of example topics that will be reviewed by the Task Force in due course, after the discharges of ALPS treated water have begun.

Regulatory Control and Authorization

- NRA’s approach to encourage optimization of protection and safety during future reviews of the authorization.
- NRA’s approach to reviewing and potentially revising discharge limits in response to TEPCO’s ongoing optimisation of protection and safety.
- NRA’s approach to identify “unusual values” and refine action limits based on incoming environmental monitoring data and other operational experience.

Safety Related Aspects of Systems and Processes for Controlling Discharges

- The implementation of maintenance plans for the various equipment and structures that make up the ALPS discharge process.
- Operational or environmental changes that would require a reassessment of the safety and potentially the change of any engineered aspects of the process.
- Identification and review of any abnormal occurrences and the subsequent actions taken by TEPCO and their interactions with NRA consistent with domestic regulatory requirements.

Characterization of the Source

- TEPCO’s and NRA’s review of the source term as 1) the decommissioning process at FDNPS continues and as the radionuclide content and other properties of contaminated water potentially change and 2) the operational ALPS technology at FDNPS potentially evolves.
- TEPCO’s consideration of changes to the source characterization as the size of the ALPS-related monitoring database – both source and environmental – grows. This will be helpful in ensuring

there is a strong connection between the characterization of the source and environmental monitoring programmes.

Radiological Environmental Impact Assessment

- Checking whether TEPCO and NRA have undertaken a periodic review of REIA.
- Reviewing TEPCO's approach to updating the REIA if information changes, including the source term, habits of the population over time and results of the environmental monitoring indicate that the REIA results need revising.
- The Task Force will review the implementation of the process put in place by the NRA to periodically review the authorization of the discharges of ALPS treated water (see Section 3.1) in the future.

Source and Environmental Monitoring

- How future results from source and environmental monitoring published by TEPCO, and by independent organizations under the CRMP, are being used to verify and demonstrate compliance with the discharge authorization and requirements for the control of public exposures.
- How environmental monitoring results are being used to verify the assumptions made for the assessment of public exposure and radiological environmental impacts
- Observation of the process utilized by the Government of Japan, NRA, and TEPCO to respond to any potential abnormal results from monitoring programmes.

Involvement of Interested Parties

- The involvement of interested parties in further regulatory steps related to the ALPS treated water discharges.
- The involvement of interested parties in potential future changes to key aspects of the discharge such as the discharge limits or design for the discharge.
- Periodic updates on the Action Plan for the Continuous Implementation of the Basic Policy on Handling of ALPS Treated Water as it relates to the involvement of interested parties.
- How interested parties are involved over time to ensure that up-to-date habit data is considered as part of future reviews of the REIA and monitoring programmes.
- Information exchange and communication, as needed, with the Governments of neighbouring countries throughout the entire time when discharges of ALPS treated water are occurring.

Occupational Radiation Protection

- Reviewing when TEPCO reassesses ALPS treated water discharge facility on a periodic basis while taking into account the evolution of the radiological conditions (including occupational

exposure data for external and internal exposures of TEPCO workers & contractors including sub-contractors) in the relevant areas and during normal operation in the future.

5.2. IAEA's Independent Sampling, Data Corroboration, and Analysis

The activities related to the corroboration of source monitoring, the corroboration of environmental monitoring, and the corroboration of occupational radiation protection; these will continue as described in Part IV above and in previous reports.

Corroboration of Source and Environmental Monitoring

The IAEA corroboration of source and environmental monitoring related to discharges of ALPS treated water from FDNPS is comprised of three distinct elements:

- Review of sampling and analytical methods for source and environmental monitoring related to ALPS treated water at FDNPS used by TEPCO and relevant Japanese authorities.
- Corroboration of source monitoring undertaken by TEPCO, including a comprehensive radiological characterization of ALPS treated water samples.
- Corroboration of environmental monitoring undertaken by TEPCO and relevant Japanese authorities.

On May 2023, the IAEA published a report [1] detailing the results of the first interlaboratory comparison conducted for the determination of radionuclides in samples of ALPS treated water. These findings provide confidence in TEPCO's capability for undertaking accurate and precise measurements related to the discharge of ALPS treated water. Furthermore, based on the observations of the IAEA, TEPCO has demonstrated that it has a sustainable and robust analytical system in place to support the ongoing technical needs at FDNPS during the discharge of ALPS treated water.

Additional sampling for the corroboration of source and environmental monitoring will occur throughout the year and on different frequencies depending on operational considerations. Future ILCs are planned for the corroboration of source monitoring in 2024, and future ILCs are planned for the corroboration of environmental monitoring later in 2023 after the discharges of ALPS treated water have begun. The ILCs will involve third party laboratories and the IAEA is currently considering additional third-party laboratories to include in these future ILCs.

Corroboration of Occupational Radiation Protection

An individual monitoring programme is designed to assess radiation doses to workers arising from exposure due to external sources of radiation and from exposure due to intakes of radionuclides. The IAEA's corroboration for occupational radiation protection capabilities is comprised of three distinct elements:

1. Corroboration of relevant Japanese individual monitoring services (IMS) capabilities for monitoring and assessing external exposure;
2. Corroboration of relevant Japanese IMS capabilities for monitoring and assessing internal exposure; and
3. Review of analytical methods in external and internal dosimetry used by the relevant Japanese IMS.

In the first half of 2023, the IAEA initiated the corroboration for external dosimetry. The IAEA has issued a contract to a secondary standards dosimetry laboratory to have dosimeters irradiated under reference conditions in support of the corroboration of external dosimetry. The irradiated dosimeters will then be returned to relevant Japanese IMS and the IAEA's RSTSL for analysis. After the relevant Japanese IMS and RSTSL have completed their analysis in the second half of 2023, the IAEA will collect and analyse the results. The IAEA will collect the results from all participating laboratories and conduct a screening to ensure that all laboratories have submitted a complete assessment package with all necessary documentation. The IAEA will draft a report highlighting the results, which will be published by the end of 2023.

Furthermore, in the second half of 2023, the IAEA will initiate the steps to conduct the corroboration for in-vitro and in-vivo internal monitoring. The IAEA will identify vendors for the urine samples spiked with certified reference materials and will ship the urine samples for in-vitro and a reference phantom for in-vivo bioassay to TEPCO as part of the ILC. RSTSL will also conduct analyses of the spiked urine samples and the phantom throughout 2024.

5.3. Real Time Monitoring

The IAEA has also chosen to display data provided by TEPCO on a real-time or near real-time basis share the status of the ALPS discharge facilities for members of the public. Many of the data points included in this real time monitoring approach are key operational parameters or controls in place and therefore provide the IAEA with insights as to the ongoing reliability of the ALPS discharge facilities; this will be combined with the insights and observations gained through other Task Force activities anticipated to occur in 2023 and beyond.

The data from TEPCO will be displayed graphically on the IAEA's website along with a short explanation to help the reader understand the different data points. Examples of data the IAEA plans to display include:

- ALPS treated water flow rates
- Seawater flow rates for dilution
- Online radiation monitors installed in multiple locations as screening measures
- Concentration of tritium after dilution

Additionally, over time, the IAEA will display the results of its independent corroboration of source and environmental monitoring, as well as the results of its corroboration of the capabilities of relevant Japanese individual monitoring services for occupational radiation protection on this website to enhance the availability of relevant data for interested parties.

5.4. IAEA Continuous Presence at the FDNPS

The IAEA, consistent with its commitment to being involved before, during, and after the ALPS treated water discharges, has a continuous presence at the FDNPS from summer 2023. The IAEA has a dedicated office at the FDNPS.

The main aspects to consider in that presence are to:

- Observe the safety aspects related to the TEPCO's Implementation Plan
- Witness the water sampling activities and the process for dispatching samples to the IAEA corroboration and third parties laboratories.
- Observe preparatory activities taken by TEPCO leading up to the start of water discharges.
- Periodically meet with NRA and observe their regulatory inspections, the activities related to the discharges of ALPS treated water and their findings.
- Routinely visit the main technical equipment and structures associated with the ALPS water discharges.
- Liaise with TEPCO if any abnormalities, deviations or changes occur during the implementation and coordinate between FDNPS and IAEA HQ.
- To coordinate future Task Force meetings at the FDNPS, as required.

REFERENCES

1. INTERNATIONAL ATOMIC ENERGY AGENCY, IAEA Review of Safety Related Aspects of Handling ALPS-Treated Water at TEPCO's Fukushima Daiichi Nuclear Power Station, First Inter-laboratory Comparison on the Determination of Radionuclides in ALPS Treated Water, IAEA, Vienna, 2023. [first_interlaboratory_comparison_on_the_determination_of_radionuclides_in_alps_treated_water.pdf \(iaea.org\)](#)
2. Secretariat of the Team for Countermeasures for Decommissioning, Contaminated Water and Treated Water. Outline of Decommissioning, Contaminated Water and Treated Water, 2023. https://www.tepco.co.jp/en/hd/decommission/information/committee/pdf/2023/roadmap_20230427_01-e.pdf
3. Subcommittee on Handling of the ALPS Treated Water. Subcommittee report, February 10, 2020. https://www.meti.go.jp/english/earthquake/nuclear/decommissioning/pdf/20200210_alps.pdf
4. INTERNATIONAL ATOMIC ENERGY AGENCY. IAEA Follow-up Review of Progress Made on Management of ALPS Treated Water and the Report of the Subcommittee on Handling of ALPS treated water at TEPCO's Fukushima Daiichi Nuclear Power Station: Review Report April 2020. <https://www.iaea.org/sites/default/files/20/04/review-report-020420.pdf>
5. INTERNATIONAL ATOMIC ENERGY AGENCY. Fukushima Daiichi ALPS Treated Water Discharge [Fukushima Daiichi Treated Water Release – Advanced Liquid Processing System \(ALPS\) | IAEA Accessed 26 June 2023.](#)
6. INTERNATIONAL ATOMIC ENERGY AGENCY, *The Agency's Health and Safety Measures*, INFCIRC/18, IAEA, Vienna (1960);
7. Government of Japan. Comprehensive Radiation Monitoring Plan April 2023 https://radioactivity.nra.go.jp/en/contents/17000/16273/24/274_20230412.pdf.
8. EUROPEAN COMMISSION, FOOD AND AGRICULTURE ORGANIZATION OF THE UNITED NATIONS, INTERNATIONAL ATOMIC ENERGY AGENCY, INTERNATIONAL LABOUR ORGANIZATION, OECD NUCLEAR ENERGY AGENCY, PAN AMERICAN HEALTH ORGANIZATION, UNITED NATIONS ENVIRONMENT PROGRAMME, WORLD HEALTH ORGANIZATION, Radiation Protection and Safety of Radiation Sources: International Basic Safety Standards, IAEA Safety Standards Series No. GSR Part 3, IAEA, Vienna (2014).
9. INTERNATIONAL ATOMIC ENERGY AGENCY, UNITED NATIONS ENVIRONMENT PROGRAMME, Regulatory Control of Radioactive Discharges to the Environment, IAEA Safety Standards Series No. GSG-9, IAEA, Vienna (2018).
10. INTERNATIONAL ATOMIC ENERGY AGENCY, UNITED NATIONS ENVIRONMENT PROGRAMME, Radiation Protection of the Public and the Environment, IAEA Safety Standards Series No. GSG-8, IAEA, Vienna (2018).
11. INTERNATIONAL ATOMIC ENERGY AGENCY, UNITED NATIONS ENVIRONMENT PROGRAMME, Prospective Radiological Environmental Impact Assessment for Facilities and Activities, IAEA Safety Standards Series No. GSG-10, IAEA, Vienna (2018).
12. INTERNATIONAL COMMISSION ON RADIOLOGICAL PROTECTION, Environmental Protection - the Concept and Use of Reference Animals and Plants. ICRP Publication 108. Ann. ICRP 38 (4-6) (2008).
13. INTERNATIONAL COMMISSION ON RADIOLOGICAL PROTECTION, Protection of the Environment under Different Exposure Situations. ICRP Publication 124. Ann. ICRP 43(1) (2014).
14. INTERNATIONAL ATOMIC ENERGY AGENCY, Governmental, Legal and Regulatory Framework for Safety, IAEA Safety Standards No. GSR Part 1 (Rev. 1), IAEA, Vienna (2016).
15. TEPCO. Implementation Plan for Fukushima Daiichi Nuclear Power Station as Specified Nuclear Facility February 20 2023, [Application Documents for Approval to Amend the Implementation Plan for Fukushima Daiichi Nuclear Power Station Specified Nuclear Facility](#)

16. INTERNATIONAL ATOMIC ENERGY AGENCY, Environmental and Source Monitoring for Purposes of Radiation Protection, IAEA Safety Standards Series No. RS-G-1.8, IAEA, Vienna (2005).
17. INTERNATIONAL COMMISSION ON RADIOLOGICAL, Age-dependent Doses to Members of the Public from Intake of Radionuclides - Part 1. ICRP Publication 56. Ann. ICRP 20 (2) (1990).
18. INTERNATIONAL COMMISSION ON RADIOLOGICAL PROTECTION, Radiation weighting for Reference Animals and Plants. ICRP Publication 148. Ann. ICRP 50(2) (2021).
19. TEPCO. Reference material – FDNPS measurement/verification tank (K4 tank group) circulation/agitation demonstration test results, 11 July, 2022 [Fukushima Daiichi Nuclear Power Station Measurement/verification tank \(K4 tank group\) circulation/agitation demonstration test results \(tepco.co.jp\)](https://www.tepco.co.jp/en/nucl/eng/ndp/ndp_k4_tank_group_circulation_agitation_demo_test_results.html)
20. INTERNATIONAL ORGANISATION FOR STANDARDISATION. Quality Management Systems - Requirements, ISO 9001:2015, Geneva, 2015.
21. INTERNATIONAL ORGANISATION FOR STANDARDISATION. General requirements for the competence of testing and calibration laboratories, ISO/IEC 17025:2017, Geneva, 2018.
22. INTERNATIONAL ORGANISATION FOR STANDARDISATION. Statistical methods for use in proficiency testing by interlaboratory comparisons, ISO 13528: 2022, Geneva, 2022.
23. INTERNATIONAL ATOMIC ENERGY AGENCY, INTERNATIONAL LABOUR OFFICE, Occupational Radiation Protection, IAEA Safety Standards Series No. GSG-7, IAEA, Vienna (2018).
24. INTERNATIONAL ATOMIC ENERGY AGENCY. Marine Radioactivity Information System (MARIS). IAEA, Vienna, <https://maris.iaea.org/home>
25. INTERNATIONAL ATOMIC ENERGY AGENCY, Generic Models for Use in Assessing the Impact of Discharges of Radioactive Substances to the Environment, IAEA Safety Report Series No. 19, IAEA, Vienna (2001).
26. INTERNATIONAL ATOMIC ENERGY AGENCY, Interlaboratory Comparisons 2017–2020: Determination of Radionuclides in Sea Water, Sediment and Fish, IAEA Analytical Quality in Nuclear Applications Series No. 67, IAEA, Vienna (2022)
27. INTERNATIONAL ATOMIC ENERGY AGENCY, Interlaboratory Comparisons 2014–2016: Determination of Radionuclides in Sea Water, Sediment and Fish, IAEA Analytical Quality in Nuclear Applications Series No. 59, IAEA, Vienna (2019)
28. INTERNATIONAL ATOMIC ENERGY AGENCY, IAEA Review of Safety Related Aspects of Handling ALPS-Treated Water at TEPCO's Fukushima Daiichi Nuclear Power Station, Report 3: Status of IAEA's Independent Sampling, Data Corroboration, and Analysis, IAEA, Vienna, 2022.
29. INTERNATIONAL ATOMIC ENERGY AGENCY, Sediment Distribution Coefficients and Concentration Factors for Biota in the Marine Environment, IAEA Technical Report Series No. 422, IAEA, Vienna, 2004.

LIST OF CONTRIBUTORS

Caruso, G.	International Atomic Energy Agency
Freeman, E.	International Atomic Energy Agency
Nikolaki, M.	International Atomic Energy Agency
Clark, A.	International Atomic Energy Agency
Brown, J.	International Atomic Energy Agency
Telleria, D.	International Atomic Energy Agency
Okyar, B.	International Atomic Energy Agency
Cruz Suarez, R.	International Atomic Energy Agency
Hajek, M.	International Atomic Energy Agency
Melhem, S.	International Atomic Energy Agency
Proehl, G.	International Atomic Energy Agency
Abraham-Ponti, C.	International Atomic Energy Agency
Bartocci, J.	International Atomic Energy Agency
Blinova, O.	International Atomic Energy Agency
Camin, F.	International Atomic Energy Agency
Cook, M.	International Atomic Energy Agency
Copia, L.	International Atomic Energy Agency
Deneke, M.	International Atomic Energy Agency
Descroix-Comanducci, F.	International Atomic Energy Agency
Dioszeghy, A.	International Atomic Energy Agency
Fujak, M.	International Atomic Energy Agency
Groening, M.	International Atomic Energy Agency
Horsky, M.	International Atomic Energy Agency
Kim, S.-B.,	International Atomic Energy Agency
Levy, I.	International Atomic Energy Agency
Matsumoto, T.	International Atomic Energy Agency
McGinnity, P.	International Atomic Energy Agency
Miller, J.	International Atomic Energy Agency
Murphy, N.	International Atomic Energy Agency
Nadalut, B.	International Atomic Energy Agency
Osvath, I.	International Atomic Energy Agency
Patterson, S.	International Atomic Energy Agency
Pham, M. K.	International Atomic Energy Agency
Pommé, S.	European Commission Joint Research Centre, Geel, Belgium
Rovan, L.	International Atomic Energy Agency
Seel, P.J.	International Atomic Energy Agency
Seslak, B.	International Atomic Energy Agency
Sobiech-Matura, K.	International Atomic Energy Agency
Tucakovic, I.	International Atomic Energy Agency
Ulanowski, A.	International Atomic Energy Agency

Independent External Experts

Gonzalez, A.	Argentina*
Tinker, R.	Australia*
Gregoire, M-C.	Canada*
Liu, S.	China*
Lachaume, J-L.	France*
Kim, H-S.	Korea, Republic of*
Gauvis, C.	Marshal Islands*
Shinkarev, S.	Russian Federation*
Nettleton, J.	United Kingdom*
Boyd, M.	United States of America*
Nguyen Q. H.	Viet Nam*

*All independent experts serve in their individual capacity

ANNEX 1

Summary of IAEA Review Missions and Published Technical Reports

The IAEA has carried out five review missions to Japan since the beginning of the IAEA's safety review in 2021. Members of the IAEA Task Force participated in these missions and each mission focused on interactions with particular Japanese authorities or TEPCO. After each of the first four review missions, the IAEA has published a technical report that reflects the discussions between the Task Force and Japanese authorities or TEPCO, as indicated, and which documents the observations and findings made by the Task Force.

- 13-19 February 2022: Review Mission to TEPCO and METI
 - 29 April 2022: Report 1 published.
- 21-25 March 2022: Review Mission to NRA
 - 16 June 2022: Report 2 published.
- 14-18 November 2022: Review Mission to TEPCO and METI
 - 5 April 2023: Report 4 is published.
- 16-20 January 2023: Review Mission to NRA
 - 4 May 2023: Report 5 published
- 29 May – 12 June 2023: Comprehensive Review Mission
 - No report was issued after the comprehensive review mission.

In addition, the IAEA has published a report on the status of the IAEA's independent sampling, data corroboration and analysis, as well as a report on the first interlaboratory comparison on the determination of radionuclides in ALPS treated water.

- 29 December 2022: Report 3 on the Status of IAEA's Independent Sampling, Data Corroboration, and Analysis is published.
- 31 May 2023: Report on the First Interlaboratory Comparison on the Determination of Radionuclides in ALPS Treated Water is published.

Copies of these reports can be downloaded from that IAEA webpage dedicated to the IAEA's ALPS safety review:

<https://www.iaea.org/topics/response/fukushima-daiichi-nuclear-accident/fukushima-daiichi-alps-treated-water-discharge/reports>

ANNEX 2

Summary of relevant international safety standards used in the IAEA safety review

1. [SF-1] EUROPEAN ATOMIC ENERGY COMMUNITY, FOOD AND AGRICULTURE ORGANIZATION OF THE UNITED NATIONS, INTERNATIONAL ATOMIC ENERGY AGENCY, INTERNATIONAL LABOUR ORGANIZATION, INTERNATIONAL MARITIME ORGANIZATION, OECD NUCLEAR ENERGY AGENCY, PAN AMERICAN HEALTH ORGANIZATION, UNITED NATIONS ENVIRONMENT PROGRAMME, WORLD HEALTH ORGANIZATION, Fundamental Safety Principles, IAEA Safety Standards Series No. SF-1, IAEA, Vienna (2006).
2. [GSG-9] INTERNATIONAL ATOMIC ENERGY AGENCY, UNITED NATIONS ENVIRONMENT PROGRAMME, Regulatory Control of Radioactive Discharges to the Environment, IAEA Safety Standards Series No. GSG-9, IAEA, Vienna (2018).
3. [GSG-10] INTERNATIONAL ATOMIC ENERGY AGENCY, UNITED NATIONS ENVIRONMENT PROGRAMME, Prospective Radiological Environmental Impact Assessment for Facilities and Activities, IAEA Safety Standards Series No. GSG-10, IAEA, Vienna (2018).
4. [GSR Part 1] INTERNATIONAL ATOMIC ENERGY AGENCY, Governmental, Legal and Regulatory Framework for Safety, IAEA Safety Standards No. GSR Part 1 (Rev. 1), IAEA, Vienna (2016).
5. [GSR Part 2] INTERNATIONAL ATOMIC ENERGY AGENCY
6. [GSR Part 3] EUROPEAN COMMISSION, FOOD AND AGRICULTURE ORGANIZATION OF THE UNITED NATIONS, INTERNATIONAL ATOMIC ENERGY AGENCY, INTERNATIONAL LABOUR ORGANIZATION, OECD NUCLEAR ENERGY AGENCY, PAN AMERICAN HEALTH ORGANIZATION, UNITED NATIONS ENVIRONMENT PROGRAMME, WORLD HEALTH ORGANIZATION, Radiation Protection and Safety of Radiation Sources: International Basic Safety Standards, IAEA Safety Standards Series No. GSR Part 3, IAEA, Vienna (2014).
7. [RS-G-1.8] INTERNATIONAL ATOMIC ENERGY AGENCY, Environmental and Source Monitoring for Purposes of Radiation Protection, IAEA Safety Standards Series No. RS-G-1.8, IAEA, Vienna 2005
8. [GSG-7] INTERNATIONAL ATOMIC ENERGY AGENCY, INTERNATIONAL LABOUR OFFICE, Occupational Radiation Protection, IAEA Safety Standards Series No. GSG-7, IAEA, Vienna (2018).
9. INTERNATIONAL ATOMIC ENERGY AGENCY, Generic Models for Use in Assessing the Impact of Discharges of Radioactive Substances to the Environment, IAEA Safety Report Series No. 19, IAEA, Vienna (2001).
10. [GSG-8] INTERNATIONAL ATOMIC ENERGY AGENCY, UNITED NATIONS ENVIRONMENT PROGRAMME, Radiation Protection of the Public and the Environment, IAEA Safety Standards Series No. GSG-8, IAEA, Vienna (2018).
11. [IAEA Safety Glossary] INTERNATIONAL ATOMIC ENERGY AGENCY, IAEA Nuclear Safety and Security Glossary, 2022 Interim Edition, IAEA, Vienna, (2022).

ANNEX 3

List of updates and amendments to TEPCO's Implementation Plan and NRA Regulatory Review Milestones

1. List of updates and amendments to TEPCO's Implementation Plan, including the REIA

- November 2021
 - https://www.tepco.co.jp/en/hd/newsroom/press/archives/2021/20211117_01.html
- December 2021
 - https://www.tepco.co.jp/en/hd/newsroom/press/archives/2021/20211221_02.html
- April 2022
 - https://www.tepco.co.jp/en/hd/newsroom/press/archives/2022/20220428_03.html
- May 2022
 - https://www.tepco.co.jp/en/hd/newsroom/press/archives/2022/20220513_01.html
- July 2022
 - https://www.tepco.co.jp/en/hd/newsroom/press/archives/2022/20220715_01.html
- November 2022
 - https://www.tepco.co.jp/en/hd/newsroom/press/archives/2022/20221114_01.html
- February 2023
 - (14th) https://www.tepco.co.jp/en/hd/newsroom/press/archives/2023/20230214_01.html
 - (20th) https://www.tepco.co.jp/en/hd/newsroom/press/archives/2023/20230220_01.html
- April 2023
 - https://www.tepco.co.jp/en/hd/newsroom/press/archives/2023/20230424_02.html

2. NRA Regulatory Review Milestones

- 24 December 2021
 - Public review meeting between NRA and TEPCO
- 11 December 2021
 - Public review meeting between NRA and TEPCO
- 20 December 2021
 - Public review meeting between NRA and TEPCO
- 27 December 2021
 - Public review meeting between NRA and TEPCO
- 1 January 2022
 - Public review meeting between NRA and TEPCO
- 7 January 2022
 - Public review meeting between NRA and TEPCO
- 15 January 2022
 - Public review meeting between NRA and TEPCO
- 25 January 2022
 - Public review meeting between NRA and TEPCO
- 1 February 2022
 - Public review meeting between NRA and TEPCO
- 10 February 2022
 - Public review meeting between NRA and TEPCO
- 18 February 2022
 - Public review meeting between NRA and TEPCO
- 11 March 2022
 - Public review meeting between NRA and TEPCO
- 15 April 2022
 - Public review meeting between NRA and TEPCO

- 19 May – 17 June 2022
 - NRA establishes a public comment period for first regulatory review results
- 22 July 2022
 - First regulatory review results approved by NRA Commission
- 21 November 2022
 - Public review meeting between NRA and TEPCO
- 7 December 2022
 - Public review meeting between NRA and TEPCO
- 21 December 2022
 - Public review meeting between NRA and TEPCO
- 27 December 2022
 - Public review meeting between NRA and TEPCO
- 17 February 2023
 - Public review meeting between NRA and TEPCO
- 23 February – 24 March 2023
 - NRA establishes a public comment period for second regulatory review results
- 10 May 2023
 - Second regulatory review results approved by NRA Commission

ANNEX 4

#Japan legal and regulatory provisions applied to the FDNPS

1. Act on the Regulation of Nuclear Source Material, Nuclear Fuel Materials Reactors “Reactor Regulation Act”

The document is related to the requirements for licensing of nuclear facilities in order to prevent accident resulting from i) nuclear fuel material, ii) material contaminated by nuclear fuel material, iii) reactors, and iv) to protect specified nuclear fuel material, and v) if necessary, to designate facilities that require special measures for the operational safety or physical protection of the specified nuclear fuel.

The following topics are explicitly included:

- The requirement for the preparation of an implementation plan for nuclear facilities including measures operational safety or physical protection of the specified nuclear fuel.
- If a facility is no longer classified as a nuclear facility, the obligation to submit an implementation plan expires.
- It has to be announced officially i) if a facility is classified a nuclear facility or ii) revoked the classification as nuclear facility.
- A licensee of the nuclear facility shall create an implementation plan to get the permission for operation.
- The modification of an approved implementation plan requires the approval of the regulatory body.
- If deemed necessary by the regulatory body, the regulatory body may request an amendment of the implementation plan.
- Any licensee of the nuclear facility shall implement measures for operational safety and physical protection of nuclear fuel material in compliance with the implementation plan.
- The licensee of a nuclear facility shall undergo an inspection conducted by the regulatory body for check compliance with the implementation plan.

2. Cabinet order on special provisions of the Act on the Regulation of Nuclear Source Material Nuclear Fuel and Reactors about the Nuclear Reactors at TEPCO’s Fukushima Daiichi Nuclear Reactors

The documents summarizes the application of specific paragraphs of the “*Act on the Regulation of Nuclear Source Material Nuclear Fuel and Reactors*” to include also the works for decommissioning of the Fukushima Daiichi Nuclear Power Station.

3. NRA Ordinance for Operational Safety and Protection of Specified Nuclear Fuel Materials of the Nuclear Reactors at TEPCO’s Fukushima Daiichi NPS

Ordinance of the Nuclear Regulation Authority No. 2 on April, 12, 2013

The document deals with aspects on operational safety and the safe handling of fuel materials. It has 42 articles, the articles 6-8, 11, 21, 23, 30, 32, 34-41 have no content.

Article 16 is the most important article regarding the discharge of ALPS treated water. It includes the possible measures to reduce radionuclide concentrations before the discharge (e.g.: filtering, evaporation, adsorption by the ion-exchange resins, storage, dilution with large volumes of water). The radionuclide concentrations shall comply with the concentration limit specified by the Nuclear Regulation Authority.

5. Notification to Establish Requirements for Operational Safety and Physical Protection of Specified Nuclear Fuel Materials of the Nuclear Reactors at TEPCO’s Fukushima Daiichi NPS

Notification No. 3 of the Nuclear Regulatory Authority on April 12, 2013

The document deals with requirements for operational safety and the safe handling of fuel materials. It has 13 articles, the articles 11 and 12 have no content.

The document provides regulatory criteria for:

- Surface density limits
- Dose Limits for Radiation Workers
- Dose Limits for Radiation Workers during Emergency Work
- Concentration Limits Radionuclides in Air at Workplaces
- Concentration Limits for Radionuclides to be discharged to the atmosphere and to water bodies.
- General guidance on calculation of doses for Workers
- Limits of radioactivity concentrations that do not require encapsulation in containers

Article 1	Record of Dose Equivalent Rate, etc
Article 2	Designation of a nuclear facility
Article 3	Standards to be Endeavoured to Observe in the Case of Storage by Electromagnetic Methods
Article 4	Surface Density Limit
Article 5	Dose Limits for Radiation Workers
Article 6	Concentration Limit for Radiation Workers
Article 7	Dose Limit for Radiation Workers Pertaining to Emergency Work
Article 8	Concentration Limit Outside the Surrounding Monitoring Area, etc
Article 9	Calculation of Dose, etc. Pertaining to External Radiation
Article 10	Criteria Pertaining to Person Responsible for Operation
Article 13	Limit of Radioactivity Concentration of Substances Contaminated by Nuclear Fuel Materials Not Required to Be Encapsulated in Containers
Article 13-2	Application Form for Approval of Measures Concerning Transport of Substances Significantly Difficult to be Encapsulated in Containers
Article 13-3	Dose Equivalent Rate for Load and Transport Equipment
Article 13-4	Hazardous Materials
Article 13-5	Sign
Article 13-6	Application Form for Approval of Special Measures
Article 13-7	Dose Equivalent Rate Pertaining to Load Subject to Special Measures
Article 13-8	Calculation of Dose Equivalent Rate Pertaining to Transport of Nuclear Fuel Material, etc. at Factory or Place of Activity
Article 14	Authority of Officials Who Conduct Inspections

6. Notification to Establish Dose Limits in Accordance with the Provisions of the NRA Ordinance on Activities of Refining Nuclear Source or Nuclear Fuel Materials, etc.

Notification No. 8 of the Nuclear Regulatory Authority on August 31, 2015

This document is referred in the “Notification to Establish Requirements for Operational Safety and Physical Protection of Specified Nuclear Fuel Materials of the Nuclear Reactors at TEPCO’s Fukushima Daiichi NPS” (Notification No. 3 of the Nuclear Regulatory Authority on April 12, 2013).

Dose limits

The document defines a dose limits for the public for effective dose of 1 mSv/a; if approved by the Nuclear Regulation Authority, the effective dose limit may be 5 mSv/a. Limits for the equivalent dose for skin and lens of the eye are 50 mSv/a and 15 mSv/a respectively.

These limits are applied in the following rules and regulations:

- Rules for Smelting
- Rules for Test Reactor
- Rules for Nuclear Raw Material Use
- Rules for Nuclear Fuel Material Use
- Rules for Processing
- Rules for Reprocessing
- Rules for Commercial Reactor
- Rules for Research and Development Reactor
- Rules for Category 1 Radioactive Waste Disposal
- Rules for Category 2 Radioactive Waste Disposal
- Rules for Radioactive Waste Management
- Rules for Storage
- Rules for Storage Contract
- Regulations on Technical Standards for Design and Construction Methods of Processing Facility
- Regulations on Technical Standards for Design and Construction Methods for Specified Waste Disposal Facility or Specified Management Facility
- Regulations on Technical Standards for Performance of Processing Facility
- Regulations on Technical Standards for Performance of Reprocessing Facility
- Regulations on Technical Standards for Commercial Power Reactors and their Affiliated Facilities
- Regulations on Technical Standards for Performance of Specified Waste Disposal Facility or Specified Management Facility
- Regulations on Technical Standards for Design and Construction Methods of Spent Fuel Storage Facility
- Regulations on Technical Standards for Performance of Spent Fuel Storage Facility
- Regulations on Technical Standards for Nuclear Power Reactor under Research and Development Stage and its Affiliated Facilities

Limits for average radionuclide concentrations

The document provides for all radioisotopes relevant for exposure on workplaces and for discharges of radionuclides to the environment the following quantities:

1. Dose coefficients for effective dose for inhalation [mSv/Bq]
2. Dose coefficients for effective dose for ingestion [mSv/Bq]
3. Limits for radionuclide concentration in air at working places [Bq/cm³]
4. Limit for radionuclide concentrations in air to be discharged from nuclear facilities to the atmosphere [Bq/cm³]
5. Limit for radionuclide concentrations in water to be discharged from nuclear facilities to water bodies [Bq/cm³]

For many isotopes, the values are given for various chemical forms. Guidance is provided how to evaluate compliance with limits. These values for maximal radionuclide concentrations are used in the following rules and regulations:

6. Rules for Test Reactor
7. Rules for Nuclear Fuel Material Use
8. Rules for Processing
9. Rules for Nuclear Raw Material Use
10. Rules for Commercial Reactor
11. Rules for Category 1 Radioactive Waste Disposal
12. Rules for Category 2 Radioactive Waste Disposal

13. Rules for Radioactive Waste Management
14. Rules for Storage
15. Regulations on Technical Standards for Design and Construction Methods of Reactors, etc. used for Research Reactor
16. Regulations on Technical Standards for Performance of Reactors, etc. Used for Research
17. Regulations on Technical Standards for Design and Construction Methods of Processing Facility
18. Regulations on Technical Standards for Performance of Reprocessing Facility
19. Regulations on Technical Standards for Commercial Power Reactors and Their Affiliated Facilities
20. Regulations on Technical Standards for Design and Construction Methods for Specified Waste Disposal Facility or Specified Management Facility,
21. Regulations on Technical Standards for Performance of Specified Waste Disposal Facility or Specified Management Facility
22. Regulations on Technical Standards for Design and Construction Methods of Spent Fuel Storage Facility
23. Regulations on Technical Standards for Performance of Spent Fuel Storage Facility,
24. Rules for Research and Development Reactor
25. Regulations on Technical Standards for Nuclear Power Reactor under Research and Development Stage and Its Affiliated Facilities

6. Items required for Measures which should be taken at Tokyo Electric Power Co., Inc.'s Fukushima Daiichi Nuclear Power Station in line with the Designation as the Specified Nuclear Facility

Decision of NRA Commission, 7 November 2012

The document summarizes the work areas to be considered during decommissioning of the damaged FDNPP. The following aspects should be taken into account and the following measures should be taken during the decommissioning work:

- Measures to be Taken with regard to the Overall Process and Risk Assessment
- Items concerning Measures to be taken for Design and Equipment
 - Monitoring of reactors
 - Removal of residual heat
 - Monitoring of primary containment atmosphere
 - Maintenance of an inert atmosphere
 - Fuel removal and, appropriate storage and management of removed fuel
 - Ensuring power source
 - Design considerations for loss of power
 - Treatment, storage, and management of radioactive solid waste
 - Treatment, storage, and management of radioactive liquid waste
 - Radiation protection, etc. in the area surrounding the site by restricting release of radioactive materials, etc.
 - Management, etc. of workers' exposure dose
 - Emergency measures
 - Design considerations
- Measures for security of the specified nuclear facility
- Measures for physical protection of specified nuclear fuel materials
- Measures for retrieval of fuel debris and reactor decommissioning
- Considerations for developing the implementation plan
- Efforts to facilitate the understanding of the implementation plan
- Review procedure for the implementation plan

ANNEX 5

Tritium in the environment

Tritium is a radioactive hydrogen isotope with one proton and two neutrons, it is the heaviest isotope of hydrogen. The physical half-life of tritium is 12.3 years. Tritium is a low-energy-beta-emitter, the mean beta-energy is only 5.7 keV.

Tritium is produced by natural and artificial processes. Naturally, tritium is generated mainly in the upper layers of the atmosphere as a result of reactions of cosmic radiation with nitrogen and oxygen. Tritium is produced in nuclear facilities, especially in nuclear power plants and reprocessing plants. For the period 1998 to 2002, in UNSCEAR [1], the average annual release of tritium from nuclear facilities was estimated to be 12 PBq and 16 PBq to the atmosphere and the aquatic environment, respectively. From nuclear installations, tritium is released predominantly as tritiated water (HTO) or elemental hydrogen, which reacts quickly with oxygen to form HTO, which then enters the global hydrological cycle.

Furthermore, anthropogenic tritium was generated during atmospheric test of nuclear weapons. According to UNSCEAR [2], during 504 atmospheric tests conducted in the period from 1945 to 1980, about 200000 PBq of tritium were released. Approximately, 95% of all tritium releases from atmospheric tests occurred in the period from 1952 to 1962.

Data on tritium concentrations in oceans were compiled and analysed by Oms et al. [3]. From these data, average tritium concentrations for the upper 500 m of the oceans were estimated for 21 compartments of the Atlantic Ocean, Indian Ocean, and Pacific Ocean. Because atmospheric nuclear weapons tests were conducted primarily in the northern hemisphere, the values are higher north of the equator than south of the equator. The tritium concentrations — decay corrected for January 1, 2016 — are in the range of 0.006-0.12 Bq/L. Standard deviations for tritium concentrations vary for the different oceanic compartments, with a range of about 15-90% of the mean. In the North Pacific, tritium concentrations are reported in the range of 0.027-0.057 Bq/L, and a mean tritium concentration of 0.057 ± 0.015 Bq/L is reported for the area between latitudes 30 N to 45 N.

In marine waters, most tritium is bound in the water as HTO. However, because tritium atoms are interchangeable with normal hydrogen atoms, some of the tritium ingested by marine organisms can be incorporated into organic compounds such as carbohydrates, fats, proteins, and other organic compounds; this tritium fraction is referred to as organically bound tritium (OBT) [1]. A tritium atom in OBT that is bound to a carbon atom is essentially fixed until the compound is metabolized (i.e., the tritium is not exchangeable). Tritium bound to oxygen, sulphur, nitrogen, or phosphorus atoms is considered readily exchangeable with hydrogen in water, so tritium in such bindings is not considered as OBT.

In the human body, the turnover of tritium bound to HTO is much faster than that of OBT tritium. This is also reflected in the dose coefficients for HTO and OBT¹. In the ICRP model [4] for estimating dose coefficients for uptake of tritium, it is assumed that 97% of HTO taken up into the blood is distributed in body water and 3% of HTO is converted to OBT. The biological half-life of tritium in humans is 10 and 40 days for HTO and OBT, respectively. The dose coefficients for ingestion for all age groups considered in ICRP are about a factor of 3 higher for OBT compared to HTO [4].

¹ The 'dose coefficient' is the committed effective dose from an intake of a radionuclide (ingestion or inhalation) for a unit intake of radioactivity. The unit is Sv/Bq. Dose coefficients are given for different age groups in [4]

INTERNATIONAL ATOMIC ENERGY AGENCY
VIENNA